2013 Geotechnical Engineering Manual

Geotechnical Engineering Section



Minnesota Department of Transportation



2013 GEOTECHNICAL ENGINEERING MANUAL I
GEOTECHNICAL ENGINEERING SECTION..... I
MINNESOTA DEPARTMENT OF TRANSPORTATION..... I

1 PURPOSE & OVERVIEW OF MANUAL 8

1.1 PURPOSE 8
1.2 GEOTECHNICAL ENGINEERING 8
1.3 OVERVIEW OF THE GEOTECHNICAL SECTION 8
1.4 MANUAL DESCRIPTION AND DEVELOPMENT 9

2 GEOTECHNICAL PLANNING 11

2.1 PURPOSE, SCOPE, RESPONSIBILITY 11
2.2 PPMS AND PROGRAMMED PROJECTS 12
2.3 GEOTECHNICAL REQUEST FORM 12
2.4 OFFICE REVIEW 12

2.4.1 *Geologic Maps* 13
2.4.2 *Existing Borings* 13
2.4.3 *Hydraulics Reports* 13
2.4.4 *Site Visit* 13
2.4.5 *Boring and In Situ Test Frequency* 14
2.4.6 *Subsurface Investigation Plan* 17

3 FIELD INVESTIGATIONS 20

3.1 UTILITY CLEARANCE 21
3.2 PROPERTY ACCESS 21
3.3 ROADWAY SAFETY AND TRAFFIC CONTROL 21

3.3.1 *Location Surveys* 21
3.3.2 *Site Clean-Up* 21

3.4 SUBSURFACE INVESTIGATIONS 22

3.4.1 *Diamond Core Drilling* 22
3.4.2 *Soil Sampling* 23
3.4.3 *Continuous Soil Sampling* 24
3.4.4 *Boring Depths* 24
3.4.5 *Field Logs* 25
3.4.6 *Borehole Sealing* 28
3.4.7 *Special Well Construction Areas* 30
3.4.8 *Transporting and Storing Samples* 30

3.5 IN SITU MEASUREMENTS 30

3.5.1 *In Situ Rock Measurements* 31
3.5.2 *Standard Penetration Test (SPT)* 31
3.5.3 *MnDOT Modified Standard Penetration Test (SPT)* 34
3.5.4 *Cone Penetration Test (CPT)* 35
3.5.5 *Flat Plate Dilatometer (DMT) (ASTM D6635-01)* 37
3.5.6 *Pressuremeter Test (PMT) (ASTM D4719)* 38
3.5.7 *Test Pits* 39
3.5.8 *Geophysical Methods* 39

3.6 GROUNDWATER INVESTIGATIONS 42

3.6.1 *Borings & Soundings* 43
3.6.2 *Piezometers* 43
3.6.3 *In-Situ Testing* 43

4 LABORATORY TESTING 44

4.1 MINIMUM TESTING RATES 44

4.2	MOISTURE CONTENT TESTS.....	44
4.3	UNCONFINED COMPRESSION TESTS	44
4.4	ONE DIMENSIONAL CONSOLIDATION TESTS	45
4.5	TRIAxIAL COMPRESSION TESTS.....	45
4.6	UNIT WEIGHT TESTS	45
4.7	SPECIFIC GRAVITY.....	46
4.8	ENGINEERING PROPERTIES	46
4.8.1	Atterberg Limit Tests.....	46
4.8.2	In-place Volume and Weight Relationships	47
4.8.3	Grain Size Analysis	49
4.8.4	Organic Content Tests.....	50
4.8.5	Unconfined Compression Tests for Rock.....	50
5	SOIL & ROCK CLASSIFICATION AND LOGGING	51
5.1	FIELD IDENTIFICATION	51
5.1.1	Texture.....	52
5.1.2	Laboratory Testing.....	54
5.2	CLASSIFICATION SYSTEMS.....	55
5.2.1	Triangular Textural	55
5.2.2	AASHTO.....	61
5.2.3	Unified Soil Classification System.....	61
5.3	ROCK CLASSIFICATION	62
5.3.1	Lithology	62
5.3.2	Rock Sample Description Standards.....	68
5.4	ROCK FORMATIONS	86
5.4.1	Boring Logs	87
5.4.2	Soil Description	87
5.4.3	Logging Procedures for Core Drilling	88
5.5	QUARRY STUDIES	89
6	GEOTECHNICAL ANALYSIS	90
6.1	DESIGN INVOLVEMENT	90
6.2	LRFD.....	91
6.2.1	Limit States	92
6.2.2	Resistance Factors	92
6.3	SHALLOW FOUNDATIONS	93
6.4	GROUND REPLACEMENT OR IMPROVEMENT FOR SHALLOW FOUNDATIONS	94
6.5	DEEP FOUNDATIONS	94
6.6	HYBRID FOUNDATIONS	95
6.7	PILE FOUNDATION DESIGN	95
6.8	DRILLED SHAFT DESIGN	96
6.9	DRAGLOAD AND DOWNDRAG	97
6.9.1	Dragload Considerations.....	97
6.9.2	Mitigation Strategies	98
6.10	CULVERTS	98
6.11	CONSTRUCTION IN PROBLEMATIC GEOTECHNICAL CONDITIONS	98
6.12	CONSTRUCTION ANALYSIS, REPORTING, AND RECOMMENDATIONS	98
6.12.1	Pre-Loading	99
6.12.2	Sheeting/Shoring.....	99
6.13	FAILURES, PROJECT FORENSICS, AND PERFORMANCE ANALYSIS	99
6.14	EMBANKMENTS & REINFORCED SOIL SLOPES	100
6.15	EROSION CONTROL	100
6.16	DRAINAGE.....	101

6.17	SETTLEMENT	101
6.18	FILL AND CUT SLOPES	101
6.18.1	<i>Soil Slopes</i>	102
6.18.2	<i>Rock Slopes</i>	102
6.19	GROUNDWATER	104
6.19.1	<i>Groundwater Occurrence</i>	107
6.19.2	<i>Engineering Hydrogeology</i>	110
6.19.3	<i>Control</i>	111
6.20	GEOSYNTHETICS	113
6.21	RETAINING WALLS	114
6.22	NOISEWALLS.....	115
6.23	HIGH-TENSION CABLE GUARDRAIL END ANCHORS	115
6.24	LIGHTWEIGHT FILL	115
6.25	UTILITIES.....	115
6.26	INFILTRATION PONDS NEAR STRUCTURES	115
7	GEOTECHNICAL REPORT	116
7.1	TYPES OF REPORTS	116
7.2	REPORT CONTENT AND PRACTICE	116
7.3	PRESENTATION OF SUBSURFACE INVESTIGATION INFORMATION.....	117
7.4	PROJECT INFORMATION	117
7.5	SUBSURFACE INVESTIGATION SUMMARY	117
7.6	GEOTECHNICAL ANALYSIS.....	118
7.7	FOUNDATION RECOMMENDATIONS	119
8	VIBRATION CONCERNS/MANAGEMENT.....	120
8.1	BLASTING	120
8.1.1	<i>Production Blasting</i>	120
8.1.2	<i>Controlled Blasting</i>	121
8.1.3	<i>Blasting Specifications</i>	122
8.2	VIBRATIONS	123
8.2.1	<i>Airborne Vibrations</i>	123
8.2.2	<i>Earthborne Vibrations</i>	124
8.2.3	<i>Vibration Sources</i>	124
8.2.4	<i>Vibration Receivers</i>	125
8.2.5	<i>Vibration Impacts (When to be concerned)</i>	126
8.2.6	<i>Damage Criteria</i>	127
8.2.7	<i>Monitoring Equipment</i>	129
8.2.8	<i>Vibration Studies</i>	129
8.2.9	<i>Measurement</i>	130
8.2.10	<i>Addressing Vibration Concerns</i>	130
9	INSTRUMENTATION AND MONITORING	132
9.1.1	<i>In Situ Instrumentation and Monitoring</i>	132
9.1.2	<i>Pre-Construction (Investigation into Time/Rate Behavior)</i>	133
9.1.3	<i>During Construction (Quality Control / Quality Assurance)</i>	134
9.1.4	<i>Post-Construction (Performance Monitoring)</i>	135
9.1.5	<i>Types of Instruments Used to Monitor Geotechnical Performance</i>	135
9.1.6	<i>Settlement Plates</i>	136
9.1.7	<i>Settlement Systems</i>	137
9.1.8	<i>Horizontal Inclinometers, In-situ Inclinometers, and ShapeAccelArrays</i>	138
9.1.9	<i>2D and 3D Position Surveys: Survey Reflectors, Targets, and Prisms</i>	140
9.1.10	<i>Piezometers (Standpipe, Drive Point, and Electronic)</i>	141

- 9.1.11 Standpipe Piezometers..... 141
- 9.1.12 Drive Point (Standpipe and Vibrating Wire)..... 141
- 9.1.13 Differences between Piezometers and Monitoring Wells 142
- 9.1.14 Vertical Slope Indicators (Manual)..... 142
- 9.1.15 Vertical Slope Indicators (Automated- In-Place Inclinometers and SAA) 142
- 9.1.16 Tiltmeters 144
- 9.1.17 Strain Gages (Resistance, Vibrating Wire, and Fiber Optic)..... 144
- 9.1.18 Specialty Strain Gages: Optical Strain Sensor Geosynthetic..... 145
- 9.1.19 (Earth/Total) Pressure Cells..... 146
- 9.1.20 Load Cells 146
- 9.1.21 Deflection/Deformation Sensors..... 147
- 9.1.22 Crackmeters 147
- 9.1.23 TDR, LiDAR, InSAR and other useful, but specialized, techniques 147
- 9.1.24 Research..... 148
- 9.2 GIMP/GEMINI..... 148
 - 9.2.1 GIMP 148
 - 9.2.2 GEMINI..... 149
- 10 INFORMATION MANAGEMENT..... 151**
 - 10.1 GENERAL POLICY 151
 - 10.2 ELECTRONIC BORING AND SOUNDING LOGS FOR STATE PROJECTS AND CSAH PROJECTS 151
 - 10.3 FILED AND ARCHIVED INFORMATION 152
 - 10.4 ROCK CORES..... 153
 - 10.5 DESIGN INFORMATION 153
 - 10.5.1 Diagrams/Drawings..... 153
 - 10.6 GINT LOGS 153
 - 10.7 FIELD LOGS (SPT AND CPT), LAB LOGS, LAB DATA 154
 - 10.8 WEB BASED DATA: GEOTECHNICAL ARCIMS, “GI5”, GIS APPLICATION 155
 - 10.9 “GEOAPP” SMART DEVICE AVAILABILITY..... 155
 - 10.10 LOCATION DATA QUALITY 155
 - 10.11 AGGREGATE SOURCE INFORMATION SYSTEM 156
 - 10.11.1 Description 156
 - 10.12 HEALTH DEPARTMENT RECORDS..... 156
 - 10.13 PROJECT CLOSE-OUT AND ARCHIVE/UPLOAD 156
 - 10.14 PROJECT BASED BORING LOG INFORMATION 157
- REFERENCES..... 158**

Cover Photo: Rock cut south of Beaver Bay on TH61

Geotechnical Engineering Section
Office of Materials & Road Research
1400 Gervais Ave
Maplewood, MN 55109

for comments or questions beth.lauzon@state.mn.us

List of Figures

FIGURE 2-1: EXAMPLE INVESTIGATION PLAN	19
FIGURE 3-1: PLACEMENT OF CORE IN A CORE BOX.....	23
FIGURE 3-2: FIELD LOG EXAMPLE	27
FIGURE 3-3 : STANDARD PENETRATION DIAGRAM	32
FIGURE 3-4: SPT TEST VARIABLES	33
FIGURE 3-5: STANDARD CPT DIAGRAM.....	36
FIGURE 3-6: TYPICAL CPT PLOT	37
FIGURE 3-7: FLAT PLATE DILATOMETER (FROM FHWA-SA-91-044)	38
FIGURE 3-8 PRESSUREMETER TESTING BEING PERFORMED TO ASSESS SOIL CONDITIONS FOR THE GLEN ROAD INTERCHANGE PROJECT ON US10/US61 IN NEWPORT, MN	39
FIGURE 4-1: ATTERBERG LIMITS RELATIONSHIPS	47
FIGURE 4-2: VOLUME AND WEIGHT RELATIONSHIPS FOR A SOIL	47
FIGURE 5-1: MNDOT TRIANGULAR TEXTURAL CLASSIFICATION	53
FIGURE 5-2: TRIANGULAR TEXTURAL CLASSIFICATION.....	56
FIGURE 5-3: GENERALIZED SOILS MAP	61
FIGURE 5-4 SAMPLE GINT LOG	70
FIGURE 5-5: SAMPLE CORE FOR RQD CALCULATION.....	82
FIGURE 6-1: ROCK CUT SLOPE DIAGRAM	103
FIGURE 6-2: SUBSURFACE WATER DIAGRAM	105
FIGURE 6-3: SCHEMATIC ILLUSTRATION OF THE OCCURRENCE OF GROUNDWATER IN AN UNCONFINED (WATER TABLE) SYSTEM (ADAPTED FROM FHWA, "HIGHWAY SUBDRAINAGE DESIGN")	106
FIGURE 6-4: CONFINED AQUIFER (ARTESIAN FLOW CONDITIONS) ADAPTED FROM FHWA, "HIGHWAY SUBDRAINAGE DESIGN"	107
FIGURE 6-5: DEEP DRAIN SYSTEM, ADAPTED FROM FHWA, "HIGHWAY SUBDRAINAGE DESIGN"	112
FIGURE 6-6: DRAINAGE BLANKET SYSTEM ADAPTED FROM FHWA, "HIGHWAY SUBDRAINAGE DESIGN"	113
FIGURE 8-1: PRODUCTION BLASTING SHOWING MOVEMENT (BULKING UP) OF THE ROCK	121
FIGURE 8-2 ROCK FACE BLASTED WITH CONTROLLED BLASTING	122
FIGURE 8-3: CUT FACE WITH BRIDGE FOUNDATION	122
FIGURE 8-4: DISTANCE AT WHICH VIBRATION LEVEL DROPS BELOW 0.1 INCH/SEC. FOR VARIOUS CONSTRUCTION RELATED ACTIVITIES. .	126
FIGURE 8-5: OSM ALTERNATIVE BLASTING CRITERIA	129

List of Tables

TABLE 2-1 MINIMUM NUMBER OF BORINGS AND MINIMUM DEPTH.....	14
TABLE 3-1: TYPES OF INVESTIGATION AVAILABLE TO THE FOUNDATIONS UNIT	20
TABLE 3-2: MINIMUM REQUIRED ROCK CORE LENGTHS	22
TABLE 3-3: SOIL TYPE AND RECOMMENDED SAMPLING TYPE.	23
TABLE 3-4: SOIL SAMPLING FREQUENCY	24
TABLE 3-5: MINIMUM BORING DEPTHS FOR VARIOUS STRUCTURES	25
TABLE 3-6: TYPICAL BLOW COUNTS FOR VARIOUS SOIL TYPES	34
TABLE 4-1: MINIMUM LAB TESTS.....	44
TABLE 5-1: VISUAL IDENTIFICATION	52
TABLE 5-2: CLASSIFICATION OF ORGANIC SOILS	59
TABLE 5-3: USCS DEFINITIONS.....	62
TABLE 5-4: WEATHERING NOMENCLATURE FOR ROCKS	73
TABLE 5-5: WEATHERING CRITERIA FOR SANDSTONE	75
TABLE 5-6: GRAIN-SIZE TERMS FOR IGNEOUS AND METAMORPHIC ROCKS	75
TABLE 5-7: GRAIN-SIZE TERMS FOR SEDIMENTARY ROCKS.....	76
TABLE 5-8: DESCRIPTION OF ATTITUDE (DIP).....	78
TABLE 5-9: JOINT AND BEDDING TERMS	78
TABLE 5-10: VOID TERMINOLOGY	79
TABLE 5-11: SCALE OF RELATIVE ROCK HARDNESS	80

TABLE 5-12: COLOR ABBREVIATIONS 81

TABLE 5-13: RQD AND ROCK QUALITY 84

TABLE 5-14: GINT LOG SHOWING RECOVERY 85

TABLE 5-15: RMR CLASSIFICATIONS ADAPTED FROM Z.T. BIENIAWSKI 86

TABLE 6-1 TYPICAL SOIL PERMEABILITY VALUES 109

TABLE 8-1: GUIDELINE VIBRATION DAMAGE POTENTIAL THRESHOLD CRITERIA (AFTER JONES & STOKES, 2004)..... 128

TABLE 8-2: GUIDELINE VIBRATION ANNOYANCE POTENTIAL CRITERIA (AFTER JONES & STOKES, 2004)..... 128

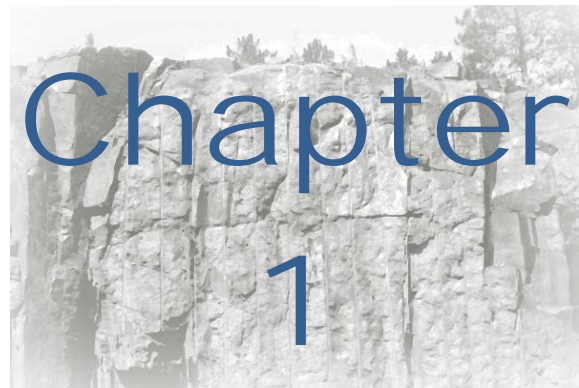

1 Purpose & Overview of Manual

This section provides general information about the use of this manual and outlines the organization of MnDOT's Geotechnical Section, its policies, and practices.

1.1 Purpose

The purpose of this manual is to describe the various procedures and descriptive terminology used by MnDOT to investigate and evaluate geotechnical site conditions for current or future transportation-related projects. The standards put forth in this manual should be used as a basis for geotechnical investigations and reports whether they are performed by MnDOT or a consultant acting on behalf of the Department.

Use of this manual does not relieve the user of the responsibility for the results of soil investigations, design of foundation components, or other geotechnical activities represented herein. Although MnDOT's Geotechnical Engineering Section's polices are generally presented, content of the manual is not intended to be exhaustive. Use of this manual must be balanced with sound geotechnical judgment.

1.2 Geotechnical Engineering

Geotechnical Engineering is concerned with the engineering properties of earth materials. At MnDOT, geotechnical activities are focused on earth materials and their interaction with transportation projects. The Geotechnical Section conducts surface and subsurface investigations to gather information about earth materials and then performs testing and analyses to arrive at appropriate solutions for construction or maintenance projects.

1.3 Overview of the Geotechnical Section

The Mission of the Geotechnical Engineering Section is to support the Office of Materials and Road Research, MnDOT Districts, Engineering Services Division and other state agencies by providing geotechnical and geological engineering expertise. The Geotechnical Section provides solutions for structural foundations, soil and rock slope engineering, aggregate quality, and applications in geosynthetics, and vibrations. The Geotechnical Engineering Section consists of three units: Geology, Foundations

and Grading & Base. Previous functions of the Aggregate Unit have been incorporated into the Geology Unit. Each unit has unique duties related to specific design aspects.

Typical Geotechnical Section activities include:

- Subsurface investigations
- Laboratory testing of soil and rock
- Foundation design
- Soil and rock slope engineering
- Aggregate resource evaluation
- Aggregate source database management
- Groundwater investigations
- Subsurface drainage design/recommendations
- Retaining wall design
- Vibration monitoring
- Geosynthetic applications
- Geotechnical support to Districts
- Project scoping
- New technology implementation
- Site monitoring and instrumentation
- Construction review and assistance
- Technical Certification

The functions of the Geology Unit and the Foundations Unit are well integrated. Together, the Units have a broad array of tools to perform geotechnical investigations and analyses. Each tool has its value and when taken together in the right combination gives an exceptional picture of subsurface characteristics. When requesting geotechnical assistance from the Geotechnical Engineering Section, please describe both the problem and the desired result and the Geotechnical Section will select the most appropriate tools for the specific concern.

1.4 Manual Description and Development

The Geotechnical Manual was originally developed and printed in 1994 as part of the Geotechnical and Pavement Manual. A few minor revisions have been made since its original publishing. A number of major additions/modifications planned for the manual, plus the desire to make the manual available electronically have led to the creation of this new Geotechnical Manual. The new manual will no longer contain elements of Pavement Engineering, which have been placed in the new 2007 Pavement Manual. The Grading & Base Unit maintains a Grading & Base Manual that deals primarily with construction related sampling, testing and inspection. There will be some overlap of topics between the Geotechnical Manual and the Grading & Base Manual.

This manual replaces the 1994 Geotechnical and Pavement Manual. It is anticipated that the new 2013 Geotechnical Manual will be available only in electronic format, available at the MnDOT Materials Engineering Website <http://www.dot.state.mn.us/materials/index.html>. All future updates of this manual will

be made on a yearly basis at the beginning of each new calendar year. Any section of the manual that has been revised will reflect the revision date in the title header.

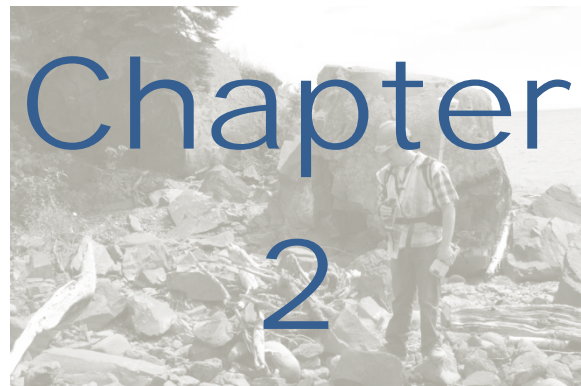

2 Geotechnical Planning

Geotechnical Investigations encompass a large range of methods and types. Surface, subsurface, and laboratory investigations all aid in obtaining necessary information for geotechnical designs. This chapter will discuss the different aspects of a geotechnical investigation and the roles that field and laboratory classification and testing play in a geotechnical design.

2.1 Purpose, Scope, Responsibility

Geotechnical investigations are an essential component of a successful geotechnical engineering analysis and foundation recommendation report. These investigations allow geotechnical engineers and geologists to characterize subsurface conditions and make engineering judgments about how the earth will behave when subjected to structure and embankment loads associated with highway construction.

Subsurface investigations include methods such as foundation drilling and in situ test methods. The subsurface soils and rock are investigated to determine properties including:

- Soil/rock stratigraphy/classification
- Soil/rock strength parameters
- Soil/rock stiffness parameters
- Groundwater conditions

MnDOT's Geotechnical Section is charged with providing subsurface investigations for transportation related structures including:

- Bridges
- Retaining Walls
- Large Culverts
- Roadway Embankments
- Buildings
- Communication and Light Towers
- Miscellaneous Structures

Surface investigations generally consist of in situ soil and rock measurements such as those conducted on bedrock outcrops, geophysical testing, quarry studies, and test pits. These types of investigations may also include a site visit to take photographs and determine potential issues.

Laboratory testing is conducted on samples from both surface and subsurface investigations of both soil and rock.

For additional information not covered in this section, please refer to the manual entitled “Subsurface Investigations-Geotechnical Site Characterization” published by the U.S. Department of Transportation, Federal Highway Administration as part of the NHI Course No. 132031.

2.2 PPMS and Programmed Projects

As a Central Office functional group, the Geotechnical Section provides a service to several areas within MnDOT including the Office of Bridges and Structures, District Design Sections, Traffic Offices and others.

Within MnDOT’s Program and Project Management System (PPMS), the Geotechnical Section is assigned an activity code of either 1190 or 1191 for roadway investigations (including retaining walls, noise walls, light poles, cable median barrier, towers, and embankments) and bridge and large culvert investigations respectively.

2.3 Geotechnical Request Form

For special requests, not included in PPMS, Districts are asked to fill out a Geotechnical Investigations & Assistance Request Form. This form should be completed for all geotechnical work requested. Updated forms can be obtained from the Foundations Unit website or by calling the MnDOT Foundations Engineer.

2.4 Office Review

An accurate and comprehensive geotechnical investigation is a key component to any geotechnical project. While most may think of subsurface investigations as consisting of fieldwork, there are many tasks that should be completed in the office prior to any fieldwork being started to aid in the overall investigation. Office tasks include researching historical data, reviewing available subsurface information and site data and planning the subsurface investigation.

All subsurface investigations should begin with a collection of existing data for the project. This may include any number of the following items:

- Geologic Maps
- Aerial Photos
- Well Records
- Piezometer Records
- Existing Borings
- Historical Bridge Plans with Plotted Borings
- Pre-Design plans, profiles and cross sections
- Historical Geotechnical Reports
- Preliminary Bridge Plans and Bridge Surveys
- Property Ownership Information
- Utility location information
- Contour Maps
- Hydraulics Report

2.4.1 Geologic Maps

If available, geologic maps should be consulted prior to a subsurface investigation to provide a reasonable idea of the site geology that may be encountered such as the rock formation and bedrock depth. The Minnesota Geological Survey provides a variety of maps and reports on the many aspects of the state's geology. A large database of bedrock as well as surficial geology maps exist at the county or the quad scale. These maps are available on their website, <http://www.mngeo.state.mn.us/index.html> in a format that can be used in ArcGIS as well as viewed PDF format. The Geology Unit also maintains a hard copy of the bedrock and surficial geology maps for much of the state. See the Geology Unit for assistance with any site-specific geology. Other types of geologic and hydrologic mapping from such as those from the DNR also exist and are useful to use in the first steps of a project.

2.4.2 Existing Borings

The Foundations Unit maintains a database of borings and soundings that have been taken by and for The MnDOT Foundations Unit. The information may be accessed through a graphical user interface showing boring locations on MnDOT base maps on the following website:

http://www.mrr.dot.state.mn.us/geotechnical/foundations/Gis/gi5_splash.html

2.4.3 Hydraulics Reports

A Hydraulics Report is generated by The Bridge Office for all bridges and large culverts crossing waterways. This report will give estimates for channel and local (pier) scour needed for pile analysis. If there is a large scour prediction, the engineer should plan to drill deeper holes to account for the loss of overburden.

2.4.4 Site Visit

Wherever possible, conduct a site visit to assess general conditions and site layout. When conditions limit the possibility of a site visit, use MnDOT's Video Log, Google Earth™, Bing™, or any similar photo mapping system. The Video Log is a collection of

videos shot by the Pavement Management Unit for roadway condition analyses and is a great resource for preliminary scoping of a project. The video is shot by a specially equipped van using several cameras, three of which give a straight on and left and right view. This video log can be a great resource for doing a preliminary scoping of a project. Other resources such as Google Earth™ and Bing™ can also provide valuable information about the project location.

2.4.5 Boring and In Situ Test Frequency

Table 2-1 outlines the minimum number of borings and/or other in situ tests required per structure type. Increase the number of borings/in situ tests required as needed based on field observation and other design considerations. Locate and space borings as topography, site conditions, soil conditions and design factors dictate. However, do not locate borings further than 30 ft. from the proposed structure location.

Table 2-1 Minimum number of borings and minimum depth

Application	Minimum number of Exploration Points	Minimum Depth of Exploration
Shallow Foundations	<p>(1) For bridge substructure widths less than or equal to 100 ft., a minimum of one SPT boring per substructure</p> <p>(2) For bridge substructure widths greater than 100 ft., a minimum of two SPT borings per substructure</p> <p>(3) For Large Box Culverts (80 sq. ft. of opening or greater), a minimum of two SPT borings per structure for culverts less than or equal to 300 ft. in length and a minimum of three SPT borings for culverts greater than 300 ft. in length</p> <p>(4) For Buildings, a minimum of one SPT boring at each building corner and one SPT boring near the center of the building</p> <p>(5) For vertical structures (light towers, radio towers, etc.) a minimum of one SPT boring per substructure</p>	<p>Depth of exploration will be:</p> <p>(1) great enough to fully penetrate unsuitable foundation soils (e.g., peat, organic silt, soft fine grained soils) into competent material of suitable bearing capacity (e.g. stiff to hard cohesive soil, compact to dense granular soil or bedrock); and</p> <p>(2) at least to a depth where stress increase due to estimated footing load is less than 15% of the applied stress at the base of the footing; and</p> <p>(3) in terms of the width of the footing: at least two times for axis-symmetric case and four times for strip footing (interpolate for intermediate cases); and</p> <p>(4) if bedrock is encountered before the depth required by item (2) above is achieved, exploration depth should be great enough to penetrate a minimum of 10 ft. into the bedrock, but rock exploration will be sufficient to characterize compressibility of infill material or near horizontal to horizontal discontinuities</p>
Deep Foundations – Driven Piles	<p>1) For bridge substructure widths less than or equal to 100 ft., a minimum of one SPT boring per substructure</p>	<p>Depth of exploration will be:</p> <p>(1) In soil, depth of exploration will extend below the anticipated pile tip</p>

	<p>(2) For bridge substructure widths greater than 100 ft., a minimum of two SPT borings per substructure</p> <p>(3) For Large Box Culverts (80 sq. ft. of opening or greater), a minimum of two SPT borings per structure for culverts less than or equal to 300 ft. in length and a minimum of three SPT borings for culverts greater than 300 ft. in length</p> <p>(4) For Buildings, a minimum of one SPT boring</p> <p>(5) For vertical structures (light towers, radio towers, etc.) a minimum of one SPT boring per substructure</p>	<p>elevation a minimum of 10 ft.</p> <p>(2) Suggested criteria for meeting (1) above is to advance boring to a depth criteria that meets MnDOT's *2,500 Aggregate N values.</p> <p>(3) All borings will extend through unsuitable strata such as unconsolidated fill, peat, highly organic materials, soft fine-grained soils, and loose coarse grained soils to reach hard or dense materials.</p> <p>(4) For pile bearing on rock, a minimum of 10 ft. of rock core will be obtained at each SPT boring to verify that the boring has not terminated on a boulder.</p>
<p>Deep Foundations – Drilled Shafts</p>	<p>(1) For bridge substructure widths less than or equal to 100 ft., a minimum of one SPT boring per substructure</p> <p>(2) For bridge substructure widths greater than 100 ft., a minimum of two SPT borings per substructure</p> <p>(3) For Large Box Culverts (80 sq. ft. of opening or greater), a minimum of two SPT borings per structure for culverts less than or equal to 300 ft. in length and a minimum of three SPT borings for culverts greater than 300 ft. in length</p> <p>(4) For Buildings, a minimum of one SPT boring</p> <p>(5) For vertical structures (light towers, radio towers, etc.) a minimum of one SPT boring per substructure</p>	<p>(1) In soil, depth of exploration will extend below the anticipated pile tip elevation a minimum of 10 ft. All borings will extend through unsuitable strata such as unconsolidated fill, peat, highly organic materials, soft fine-grained soils, and loose coarse grained soils to reach hard or dense materials.</p> <p>(2) If bedrock is encountered before the depth required by item 1 above is achieved, exploration depth should be great enough to penetrate a minimum of 10 ft. below the anticipated shaft tip elevation.</p>
<p>Retaining Walls</p>	<p>(1) A minimum of one SPT boring per retaining wall</p> <p>(2) For retaining walls more than 100 ft. in length: (a) one SPT boring spaced every 400 ft. and one CPT sounding every 100 ft.; or (b) one SPT boring spaced every 150 ft.</p> <p>(3) For anchored walls, additional SPT borings or CPT soundings in the anchorage zone spaced at 200 ft.</p> <p>(4) For MSE and Soil Nail Walls</p>	<p>(1) Investigate to a depth below bottom of wall three times the wall height or a minimum of 10 ft. into bedrock</p> <p>(2) Exploration depths should be great enough to fully penetrate soft highly compressible soils (e.g. peat, organic silt, soft fine grained soils) into competent material of suitable bearing capacity (e.g. stiff to hard cohesive soil, compact dense granular soil, or bedrock).</p>

	additional SPT borings or CPT soundings at a distance of 1.0 to 1.5 times the height of the wall behind the wall face spaced at 200 ft.	
Embankment Foundations over highly compressible materials (e.g. peat, organic silt, soft fine grained soils)	<p>(1) A minimum of one SPT boring every 200 ft. (erratic conditions) to 400 ft. (uniform conditions) of embankment length along centerline of embankment</p> <p>(2) At critical locations, (e.g. maximum embankment heights, maximum depths of soft strata) a minimum of three SPT borings in the transverse direction to define the existing subsurface conditions for stability analyses</p> <p>(3) For bridge approach embankments, at least one SPT boring at abutment locations</p>	<p>(1) Embankment depth will be, at a minimum, equal to twice the embankment height unless a hard stratum is encountered above this depth.</p> <p>(2) If soft strata are encountered extending to a depth greater than twice the embankment height, the exploration depth should be great enough to fully penetrate the soft strata into competent material (e.g. stiff to hard cohesive soil, compact to dense granular soil, or bedrock). The investigation is intended to completely characterize the soft or compressible layers.</p>
Cut Slopes	<p>(1) A minimum of one SPT boring every 200 ft. (erratic conditions) to 400 ft. (uniform conditions) of slope length</p> <p>(2) At critical locations (e.g. maximum cut depths, maximum depths of soft strata) a minimum of three SPT borings in the transverse direction to define the subsurface conditions for stability analyses</p> <p>(3) For cut slopes in rock, perform geologic mapping along the length of the cut slope</p>	<p>(1) Exploration depth will be, at a minimum, 15 ft below the minimum elevation of the cut unless a hard stratum is encountered below the minimum elevation of the cut.</p> <p>(2) Exploration depth will be great enough to fully penetrate through soft strata into competent material (e.g. stiff to hard cohesive soil, compact to dense granular soil or bedrock)</p> <p>(3) In locations where the base of the cut is below ground-water level, increase depth of exploration as needed to determine the depth of underlying pervious strata.</p>
Cable Median Barrier Anchor	<p>(1) A minimum of one SPT boring for each anchor location</p> <p>(2) Boring must be within 25 ft. of anchor location</p>	(1) Exploration depth will be a minimum of 25 ft. below the existing ground surface
Buildings	(1) In general, advance borings near the building corners and at center locations based on the size of the structure. Borings should have a regular distribution across the building footprint	<p>(1) Extend borings to a depth at least twice the shortest length/width of a shallow foundation.</p> <p>(2) If deep foundations are required, borings are to be extended to a bearing strata; depth will vary depending on design load.</p>
Other Sites or Structures	(2) Develop a boring plan which assures that borings are taken at a sufficient frequency to characterize the site appropriately. Account for site variability.	(3) Take borings to a sufficient depth (accounting for any cuts or fills) for the project needs.

*2500 Aggregate SPT N60 blows:

Bridge foundation undisturbed borings will be taken to a depth below footing elevation that will produce a total blow count of 2,500, based on N values corrected for a standard hammer energy of 60% (N_{60}).

Total blow count will be determined by averaging the N_{60} values throughout a uniform layer (with similar blow counts) and multiplying by the thickness of the layer in feet.

The region above the footing elevation and areas where blow counts are less than 15 blows per foot will be disregarded (disregard blows and layer thickness). For the purpose of determining depth of borings and for those structures for which no footing elevations are given herein, the footing elevation will be assumed to be 5 feet below the in place ground elevation.

Borings will be made to the depth specified regardless of the type of material and water condition encountered, including boulders, fill, other types of obstructions and artesian conditions.

High blow counts that are not representative of the strata from which they were taken are to be recorded but disregarded (for example, driving against a boulder).

Penetration resistances in hard, uniform material where penetration is less than 1.0 feet per 50 blows will be calculated as though the sample had been driven the entire foot. For example, if penetration is 0.5 feet in 50 blows, the blow count in this case would be 100. (This is for calculating criteria only; the actual penetration resistance of 50/.5 foot will be noted on the field log.)

If the required blow count of 2,500 is reached and the blow count on the final sample is less than $\frac{1}{2}$ that of the sample preceding it, sampling will continue to the next zone of harder material. A minimum of two samples will be obtained in the harder material.

If refusal on possible bedrock or boulders or detached bedrock is encountered before the required blow count of 2,500 is reached, the rock will be plug drilled or cored a minimum of 10 ft. to discern between bedrock and a boulder field. For plug drilling, wash samples (cuttings) will be taken and retained for rock classification and formation and member information.

All bridge borings in soil will be carried to a depth of not less than fifty feet below proposed bridge footing elevation unless bedrock is encountered.

2.4.6 Subsurface Investigation Plan

Prepare a boring plan for the field crews as a final step in the subsurface investigation planning process. A complete, detailed, boring plan will help the field crews do their job more efficiently. Include a plan view to scale of the investigation area that shows the following items:

Existing topography, utilities, and contours
 Existing Right-of-Way lines
 Proposed Alignments
 Proposed Structures
 Proposed Boreholes, CPT Soundings, other In-situ tests with symbols, labels
 and county coordinates
 State Project Number
 Charge Identifier (CID; used for timesheet and expense purposes)
 North Arrow
 Street and highway labels
 Site Plan (reference to nearest city)

Proposed advances may be labeled for field crews by office personnel, or numbered sequentially in the field. There are benefits and drawbacks to each method; presently time at which the borings are labeled is determined by engineers' preference. Unique Numbers are generally assigned after all the borings for an investigation phase (or the whole investigation) is complete. This grouping helps keep project information more organized and extends from a historic practice where Unique Numbers were assigned only at the time a report was generated. [It should be noted that this practice has occasionally made borings that were advanced, but not included in reports, difficult to find in the project archives].

Proposed borings and in-situ tests should be labeled as follows:

Foundation Borings.....T (i.e. T04)
 DMT pushes.....D
 CPT Soundings.....C

Specialty CPT soundings may also have letters at the end of the designation to indicate additional testing:

Seismic CPT....SE
 Video.....V (i.e. C07V)
 Sampling.....S
 Resistivity.....R (i.e. C02R)

Labeling for borings with instrumentation is slightly different; following the boring ID (T, D, C) and the number associated with the advance, a "trailing" designation is included, similar to the specialty designation of the CPT soundings.

Where piezometers are installed should include a "P" at the end of the name; similarly, borings with slope inclinometers installed should include an "SI" designation at the end of the name.

Piezometers.....(i.e. T05P, C04P)
 Slope Inclinometers.....(i.e. T13SI)

Where multiple codes are needed to describe an advance completely, the designations are additive. A videocone push where a push-in piezometer is left in place would be designated C#VP. Similarly, a boring with both piezometers and an inclinometer would be labeled T#PSI.

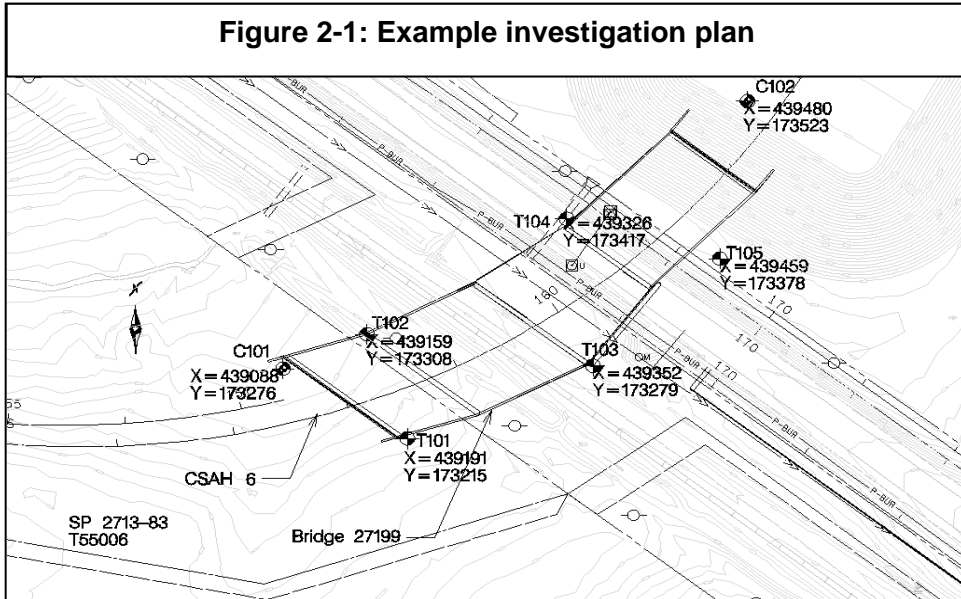

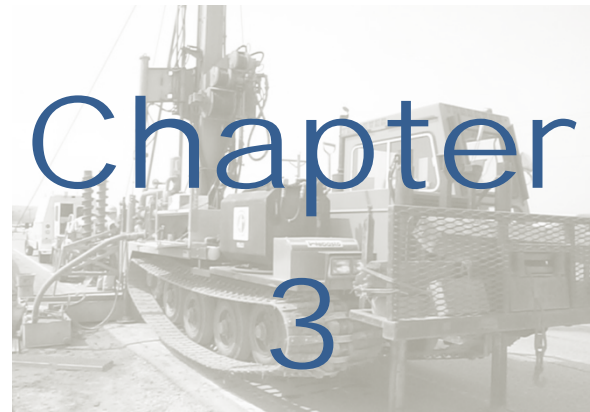

3 Field Investigations

After collecting data, evaluate the information from the office review and determine the type and sequence of testing that will provide the most comprehensive geotechnical characterization of a site. In order to efficiently utilize resources, follow a targeted approach to site investigation. A typical sequence begins with a geophysical investigation to gain a global view of the subsurface conditions and identify potential areas of concern. Use the cone penetration test (CPT) to verify strata identified by the geophysics investigation and further identify potential areas of concern for the drilling and sampling stage. At a minimum, the final stage of the investigation includes drilling and sampling areas and layers that have been identified as possible concerns. Expand the investigation scope as needed to address site specific issues and satisfy design requirements by augmenting the number of in situ tests performed, increasing the area for testing, and/or utilizing other available test methods. The following table summarizes the different investigation methods available to the Foundations Unit and their uses.

Method	In-Situ Test	Sample Type	Uses
Standard Foundation Borings	SPT	2 in. Split Spoon and 3 in. Thinwall	Stratigraphy, Soil strength and stiffness
Cone Penetration Test	Tip Stress, Sleeve stress, pore pressure	1 in. CPT sampling tube	Stratigraphy, Soil strength
CPT Seismic	Shear Wave Velocity	None	Soil stiffness
CPT Resistivity	Resistivity	None	Stratigraphy
DMT (flat plate dilatometer)	Limit Pressure	None	Soil stiffness
Pressuremeter	Limit Pressure	None	Soil stiffness
CPT Video Cone	Video	None	Stratigraphy
Geophysical	Electrical Resistivity Imaging, Seismic Methods	None	Stratigraphy

Each investigation method listed above has advantages and limitations that should be considered when planning a subsurface investigation. Consider carefully the pros and cons of each investigation method available before selecting it as part of the field investigation plan. See the following sections of this manual for further information on the advantages and disadvantages of a given procedure.

The following sections provide a description of field investigation methods at MnDOT.

3.1 Utility Clearance

The Field Crew Chief will contact utility companies prior to taking borings and will assure that in place utility structures will not be encountered.

3.2 Property Access

The Field Crew Chief will work with The District to obtain permission from property owners to take all borings that are located on property not currently owned by MnDOT. □

3.3 Roadway Safety and Traffic Control

Prior to starting work on MnDOT projects, notification will be given to the District/Metro Division Soils Engineer. In addition, the Field Crew Chief will be responsible for providing proper temporary traffic control when working on MnDOT Right-of-Way. The Field Crew Chief should obtain and follow the guidelines in the most recent version of the MnDOT Field Manual entitled "Temporary Traffic Control Zone Layouts".

3.3.1 Location Surveys

Provide a map and location data for all in situ tests performed. Indicate the location of boreholes, SPT's, CPT's, DMT's, piezometers, or any similar type test method on the test log using the corresponding county coordinate system. Be sure the accuracy of the test location is within 6 inches. Where possible, use a GPS unit with a minimum accuracy of ± 6 inches.

Preliminary and final survey information will be included for each borehole. This information will include the following:

- A horizontal and vertical tie in to permanent structures (can be in the form of a sketch)
- NAD 83 County Coordinates or Universal Transverse Mercator Coordinates (UTMs)
- MSL (mean sea level) reference elevations (NAVD 88) taken from known benchmarks accurate to ± 0.1 ft.
- Station offset information for current alignment designators.

3.3.2 Site Clean-Up

Upon completion of the field investigation work all surplus material, temporary structures and debris on land and water resulting from the work performed will be removed and the

premises left in a neat, orderly condition. Any improvements disturbed during boring operations will be restored in kind and character existing before the work was started.

3.4 Subsurface Investigations

Either the Rotary Drill Method or Hollow Stem Auger Method will be considered satisfactory for advancing the boring and recovery of undisturbed samples. Conduct the Rotary Drill Method as described in section 7.5.1.4 in the AASHTO Manual on Subsurface Investigations (1988). The use of casing will be at the discretion of the Field Crew Chief, except that the casing shoe or bit will never extend below the top of any interval to be sampled. Remove all casing upon completion of the boring. Conduct the Hollow Stem Auger Method as described in section 7.5.1.5 in the AASHTO Manual on Subsurface Investigations (1988).

3.4.1 Diamond Core Drilling

Diamond core drilling for site investigation will proceed in accordance with ASTM Designation D 2113-70 (or the most current specification) with the following exceptions:

Either NQ or NMX Barrel sizes may be used

The method of plug drilling will be at the discretion of the driller.

Wash samples will be taken during the period of plug drilling.

When bedrock is encountered, the rock will be cored and/or plug drilled as shown on the following table.

Table 3-2: Minimum Required rock core lengths			
	Depth below proposed footing elevation to top of bedrock		
	0-10 ft.	10-20 ft.	>20 ft.
Bridge	30 ft. core	20 ft. core	10 ft. core
Retaining Walls/ Culverts	10 ft. core	5 ft. core or plug drill 5 ft.	5 ft. core or plug drill 5 ft.

For other structures or geotechnical features, contact MnDOT's Foundations Engineer for minimum rock core requirements.

Placement of Rock in a Core Box

When core drilling is required, remove the core from the barrel, taking care not to disturb the sample. When possible, wrap core in plastic wrap to retain the moisture level in the core. Place the core into the box as shown in Figure 3-1. Write the starting and ending depth on wooden blocks located at the start and end of the core run. Be sure to mark with a line across the break any man made breaks that occur during the drilling or placement process. Typically, cores are sampled in 5-foot intervals. If, however, the length of the core run is less than 5 feet, more than one core run may fit into the box. Place a block between the two cores showing the ending depth of the first core and the starting depth of the second core. Write the information regarding the name of the project, structure number, location, and depth information on the side of the box.

Figure 3-1: Placement of Core in a Core Box

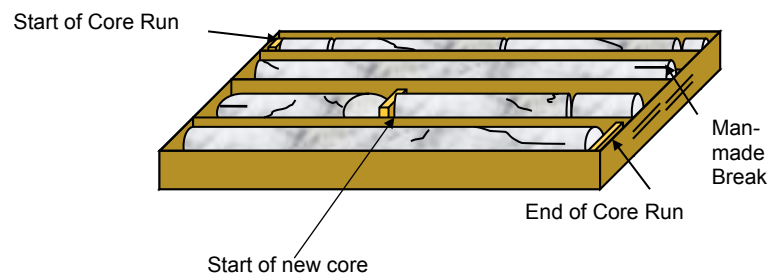

3.4.2 Soil Sampling

Implementation of the thin-Walled Tube Sampling of Soils will proceed in accordance with ASTM Designation D 1587-74, with the following exceptions.

Thin wall samplers will be three inches in outside diameter.

The length of push will not exceed 24 inches.

The sampling method is dictated by the soil type being tested. Use Table 3-3 as a guide to decide what sample method to use during acquisition.

Soil Type	Type of Sampling
Granular Soils	Split-tube
Plastic (cohesive) Soils (N<30)	Alternate split-tube and thin-wall
Plastic (cohesive) Soils (N>30)	Split-tube
Organic Soils	Thin-wall

Start sampling at the in place ground elevation or at the bottom of water when the ground is submerged. Set the frequency of soil sampling as follows:

Depth	Sample Rate
0-50 ft.	2 samples per 5 ft. interval
50-100 ft.	1 sample per 5 ft. interval
>100 ft.	1 sample per 10 ft. interval

3.4.3 Continuous Soil Sampling

Over the years, special soil sampling devices have been developed to allow continuous soil samples (up to 5 ft. long) to be retrieved to aid in soil classification and testing. The earlier versions consist of conventional thick walled tubes advanced with hollow stem augers with inside diameters ranging from 24-30 inches. Soil is typically captured in a thin acrylic cylinder for transport and easy viewing. More modern versions of continuous soils samples employ hydraulic push systems with smaller diameter samplers. The most common system used in Minnesota is the Geoprobe system, which can produce a 5 ft. continuous soil sample 1.5 in. diameter. The Geoprobe is a stand-alone system and can retrieve samples in most soil conditions. If dense or hard layers hinder operations, a percussive vibrating procedure may be used for deeper penetration. Because Geoprobe samples are very small diameter and highly disturbed by the retrieval process, they can only be used for soil classification and moisture testing.

3.4.4 Boring Depths

Borings will extend to depths sufficient to define the subsurface profile for structures, embankments and geotechnical features. Table 3-5 outlines the minimum boring depths for different structures.

Extend bridge foundation borings to a depth where a cumulative blow count of 2500 is achieved. Exclude the blow counts from above the bottom elevation of footing and areas where blow counts are less than 20 blows per foot. In areas subject to scour, exclude the blow counts of all areas above the scour elevation. Base the 2500 blow counts on the N_{60} values and not the uncorrected N values. For every SPT taken below the proposed footing elevation, consider the N_{60} value valid for the length between the SPT and the previous SPT, i.e. multiply the N_{60} value by the distance between two consecutive SPT's to obtain an estimate of the total blow counts for a given area. If the bottom of footing elevation is unknown, assume the bottom of footing to be 10 feet below the existing ground elevation. In cases where a depth is specified, drill the boring to at least the specified depth regardless of type of material, water conditions

encountered, or other geological obstructions. When a boring depth is specified, bridge foundation borings may exceed the limit of 2500 blows.

Table 3-5: Minimum boring depths for various structures	
Structure/Feature	Minimum boring depth
Bridges	Variable, based on 2500 blow criteria listed
Retaining Walls	25 ft. below proposed bottom of footing
Noise Walls	25 ft. below proposed final groundline
Large Box Culverts	25 ft. below proposed bottom of box culvert
Swamps/Organic Soils Deposits	15 ft. below swamp bottom
High Embankments (embankment height greater than 15 ft.)	40 ft.
Other structures or geotechnical features	Contact MnDOT's Foundations Engineer for minimum depth

Record but disregard high blow counts that are not representative of the strata from which they were taken (for example, driving against a boulder). Calculate penetration resistances in hard, uniform material where penetration is less than 1.0 feet per 50 blows as though the sample had been driven the entire foot. For example, if penetration is 0.5 feet in 50 blows, the blow count in this case would be 100. (This is for calculating criteria only; the actual penetration resistance of 50/0.5 foot will be noted on the field log.)

If the required blow count of 2500 is reached and the blow count on the final sample is less than half that of the sample preceding it, continue sampling to the next zone of harder material. Obtain a minimum of two samples in the harder material.

If refusal on possible bedrock, boulders or detached bedrock is encountered before the required blow count of 2500 is reached, plug drill or core rock a minimum of 10 ft. to discern between bedrock and a boulder field. For plug drilling, wash samples (cuttings) will be taken and retained for rock classification and formation and member information.

In soil, carry bridge borings to at least sixty feet below the proposed bridge footing elevation unless bedrock is encountered or otherwise instructed by the engineer.

3.4.5 Field Logs

Prepare a field log setting forth pertinent information for each boring. Write field boring logs in ink and include a copy with the final project report. Include the following information on the field boring log.

1. The project identification and bridge number or job description, boring number.
2. Location of boring referenced to centerline survey stationing measured to nearest foot. As well as GPS location information if acquired.
3. Method of drilling and sampling employed.
4. Diameter of boring.
5. Date of start and completion of boring.
6. Name of driller and crew.
7. Preliminary ground surface elevation of boring to nearest 0.5 feet (if vertical reference is available). Report final surveyed elevation on the final boring log.
8. Sheet number and total number of log sheets.
9. Definition of all symbols not otherwise self-explanatory.
10. Description of each layer encountered and sample obtained; including information pertaining to color, strength, moisture content, composition, and degree of compactness.
11. Field number of each sample, type of sample and depth at which taken.
12. Depth at which obstacles were encountered in advancing the boring. Depth to which casing was driven.
13. Number of blows in six-inch increments required to drive sampler during Standard Penetration Test.
14. Length of each run for rock core and length of core recovered.
15. Record of type of cuttings flushed to surface while plug drilling.
16. Depth where drilling mud return circulation was lost.
17. Changes occurring in rate of advance of bit.
18. Reason for abandoning boring in the event specified depth was not reached.
19. Water measurement data.
20. Description of drill rig and type of SPT hammer used.
21. Any other unusual conditions encountered during drilling and sampling
22. To be filled out in the lab

Figure 3-2 shows a sample boring log.

Figure 3-2: Field Log Example



MINNESOTA DEPARTMENT OF TRANSPORTATION
 GEOTECHNICAL ENGINEERING SECTION - FOUNDATIONS UNIT
 SUBSURFACE EXPLORATION-FIELD LOG AND LABORATORY DATA SHEET

8 Sheet 1 of _____

UNIQUE NUMBER

S.P. 1	T.H. 1	Bridge No. or Job Description 1	Boring No. 1	Ground Elevation 7
Location Information (TH, Station, Offset, etc.) (Draw Map on Back) 2			Structure Type <input type="checkbox"/> Bridge Abut <input type="checkbox"/> Swamp <input type="checkbox"/> Bridge Pier <input type="checkbox"/> Slope/Slide <input type="checkbox"/> Ret Wall <input type="checkbox"/> Roadway <input type="checkbox"/> Culvert <input type="checkbox"/> Other _____	
GPS Northing 2		GPS Easting:	GPS Coordinate System:	
Supervisor 6	Driller & Helper 6	Drill Rig 20	gINT Filename	
Date Drilling Started 5	Date Drilling Completed 5	In-Situ Test Modified SPT - Standard Energy of 60-70% of 140 lb. Hammer and 30 in. drop	Undisturbed Sample 3 in. Thinwall (Shelby Tube)	

Water Measurement Record 19

NOTE: All depths measured from ground surface

Water Depth	Date	Time	Drilling Method at time of Measurement	Hole Depth	Hole Open To	Remarks

Geotechnical Instrumentation <input type="checkbox"/> Slope Indicator <input type="checkbox"/> 2 in. PVC Piezometer <input type="checkbox"/> Monitoring Well <input type="checkbox"/> Other _____ Date Installed _____	Borehole Type <input type="checkbox"/> Environmental Borehole (EBH) <input type="checkbox"/> Non Environmental Borehole	Hole Backfill Material <input type="checkbox"/> Bentonite Grout <input type="checkbox"/> Cement Grout <input type="checkbox"/> Native Material (Not for EBH) <input type="checkbox"/> Dry Bentonite (Not for EBH)
Notes:		

9

- SOIL/MATERIAL TYPE**
- C Clay
 - L Loam
 - S Sand
 - Silt Silt
 - CL Clay Loam
 - SL Sandy Loam
 - SIL Silt Loam
 - G Gravel
 - Bldr Boulder (+3 in.)
 - Lmst Limestone
 - Shale Shale
 - Sst Sandstone
 - Dolo Dolostone
- MOISTURE CONDITION**
- dry
 - damp
 - moist
 - wet
 - sat
 - artesian
 - flowing artesian
- PLASTICITY**
- slpl slightly plastic
 - pl plastic
- ORGANIC CONTENT**
- slorg slightly organic
 - org organic
 - peat Peat
- COLOR**
- blk Black
 - brn Brown
 - grn Gray
 - yel Yellow
 - blu Blue
 - wht White
 - grn Green
 - red Red
 - dk Dark
 - lt Light

ABBREVIATIONS AND DEFINITIONS

- DESCRIPTORS**
- wx weathered
 - seams 1/2 in. thick
 - layers +2 in. thick
 - fil not native materials
 - ts topsoil
 - IOS Iron Oxide Stained
- MISCELLANEOUS**
- w/ with
 - w/o without
 - NA not applicable
- WATER MEASUREMENT**
- AB After Bailing
 - AC After Completion
 - AF After Flushing
 - w/C with Casing
 - w/M with Mud
 - WSD White Sampling/Drilling
 - w/AUG with Auger
- OPERATION**
- AUG Augered
 - A/P Augered & Plug Drilled
 - CD Core Drilled
 - DBD Disturbed by Drilling
 - PD Plug Drilled
 - ST Split Tube (SPT)
 - TW Thin Wall (Shelby Tube)
 - WS Wash Sample
 - NSR No Sample Retrieved
 - WH Weight of Hammer
 - WR Weight of Rod
 - Mud various drilling fluids and additives
 - CS Continuous Sample (5 ft. sampler)

- Hole Labels**
- C... Standard CPT
 - CV... Video CPT
 - CS... CPT w/ Sampler
 - CT... Adj. to SPT
 - CX... Swamp Verify
 - T... Std. SPT Boring
 - TC... Adj. to CPT
 - TP... Piezometer
 - TSI... Slope Incln.
 - TX... Swamp Verify

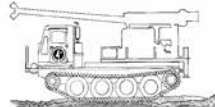
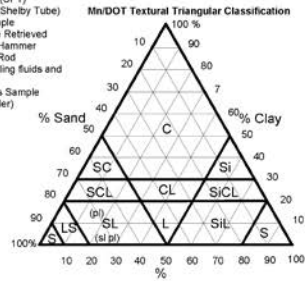

GRAIN SIZE
 G:\GEOTECH\PUBLIC\FORMS\FIELDLOG2005.DOC September 2004

FIELD LOG DATA SHEET										LABORATORY DATA SHEET									
S.P. 1		Bridge No. 1		Boring No. 1		written by 6		SHEET 2 OF SHEETS		Soilclass. by:		Date:		Rock class. by:		Date:			
Depth ft.	DATE	REMARKS mud, casing, core size, etc.	SAMPLE NO.		OPER.	SPT Core Rec.	FIELD CLASSIFICATION soil, rock, color, etc.	Moist.	Molst.	Density Wet WT.	Cohesion		Friction	Core Values		CLASSIFICATION	Depth ft.		
			LAB	FIELD							COH	Pictorial		2	3			4	5
5		12.16, 17, 21 Any changes that occur during drilling	11.		3	10 & 15, Layer & Sample descriptions													
					13, 14	Method of Drilling and Sampling													

3.4.6 Borehole Sealing

Backfill or seal all foundation borings and CPT soundings in accordance with the Minnesota Rules, Chapter 4725, Rules Relating to Wells and Borings, effective August 4, 2008 including the revisions of march 31, 2011 and any current revisions.

MnDOT policy is that borings that meet the criteria for Environmental Bore Holes (EBH) will not be drilled by MnDOT solid-stem auger rigs, since they are not licensed by the Minnesota Department of Health and do not have the capability of properly grouting bore holes. To avoid a boring becoming an EBH, do not penetrate a confining layer or advance a boring beyond 25 feet with a solid-stem auger. Solid-stem auger borings may be used to drill through any mineral soil placed by prior construction such as backfill of swamp or muck excavation without being considered an EBH.

The following is an excerpt from Minnesota Rules, Chapter 4725, Rules Relating to Wells and Borings:

In order for an excavation or drill hole to be considered an Environmental Bore Hole, it must meet ALL three conditions:

THE DRILL HOLE MUST INTERCEPT A WATER-BEARING LAYER. For the purposes of the rules, a water-bearing layer is interpreted to mean an aquifer. An aquifer is a saturated geologic material that can transmit sufficient quantity of water to supply a well. An aquifer will have a hydraulic conductivity of 10^{-6} cm/sec or greater.

Typically, an aquifer will have a sustained yield of 0.25 gallons per minute or greater. For the purposes of the rule, an artificially created basin, not hydraulically connected (less than 10^{-6} cm/sec hydraulic conductivity) to the earth outside the artificial basin, is not considered a water-bearing layer. Such basins may include a landfill liner or an excavated basin in clay for petroleum tanks.

THE DRILL HOLE MUST BE EITHER DEEPER THAN 25 FEET OR PENETRATE A CONFINING LAYER. The depth is measured to the deepest penetration of the drill hole. A confining layer in unconsolidated materials or rock, other than the Paleozoic confining layers as specified in part 4725.2020, must be a minimum of 10 feet thick. If 10 feet of a confining layer is penetrated, the drill hole is an environmental bore hole. Peat and muck-swamp deposits are not considered confining layers.

THE DRILL HOLE MUST BE USED FOR TESTING WITHOUT EXTRACTING WATER OR BE USED FOR VENTING, VAPOR RECOVERY, OR SPARGING TO REMOVE SOIL OR GROUNDWATER CONTAMINATION. Testing includes measuring a water level, testing earth properties or obtaining geologic samples for identification or other testing.

Examples of environmental bore holes include piezometers, soil borings, geologic test holes, inclinometers, pressure transducers, and vents or air sparging points that meet the requirements of the definition and paragraph above.

An excavation from which a water sample is removed is a monitoring well, not an environmental bore hole.

Please note that the required owner's copy of the sealing records should be sent to the MnDOT Foundations Engineer at the following address:

Foundations Engineer
Geotechnical Engineering Section
Minnesota Department of Transportation
1400 Gervais Avenue
Maplewood, MN 55109

Constructing a piezometer in a bore hole that does not meet the criteria for an EBH is permitted, since being a piezometer does not change the status of the hole. However, auger borings or piezometers shall not be used to extract water samples regardless of the depth, since such usage would place them under the category of monitoring wells.

Should the conditions which define an EBH be unexpectedly encountered during drilling, work shall be stopped and the next level supervisor contacted immediately for further instructions.

The Foundations Unit is equipped and licensed to drill and seal EBH's and should be contacted when such borings are necessary or anticipated.

All auger borings shall be backfilled with the drill cuttings, on-site soils, or imported material, with a texture and permeability similar to materials encountered in the bore holes. Imported backfill materials should have a lower permeability than material encountered. The bore holes shall be completely filled from the bottom or cave-in depth to the original ground surface. Tamping or compacting the backfill material should be performed as necessary to minimize voids or backfill subsidence. Backfilling shall be performed in a timely manner after completion of the bore hole.

Auger borings shall not be permitted in known or suspected contaminated areas regardless of boring depth or groundwater elevation. If contamination of any type is noted while drilling, work shall be stopped and the next level of supervisor contacted immediately for further instructions.

Backfill holes in such a manner as to ensure against subsequent damage to farm tilling and harvesting equipment and subsequent settlement of the backfilling resulting in a hole hazardous to persons, animals, or equipment. If flowing artesian conditions are encountered it will be the driller's responsibility to see that the flow is stopped, that the source is properly sealed against future leakage, and to prevent water from infiltrating other strata.

3.4.7 Special Well Construction Areas

The Minnesota department of Health identifies areas where groundwater contamination has, or may, result in risk to the public health. Special construction requirements are imposed in these areas. Anyone proposing to construct a well or boring in these areas must contact the Minnesota Department of Health prior to construction. Further information and special well construction area locations can be found on the Minnesota Department of Health website

<http://www.health.state.mn.us/divs/eh/wells/>. The locations of the special well construction areas can also be found on the Minnesota Department of Health website on the county well index

<http://mdh-agua.health.state.mn.us/cwi/cwiViewer.htm>.

3.4.8 Transporting and Storing Samples

Special care should be taken to store and transport soil and rock samples recovered from foundation borings. All thinwall samples should be stored and transported in an upright position with the original vertical orientation. All samples should be stored in above freezing temperatures. Rock core should be wrapped in plastic wrap to retain its moisture level.

3.5 In Situ Measurements

Valuable information can also be obtained from investigations undertaken at or near the natural or existing surface. Geophysical investigations, in situ rock & soil

measurements, investigation of nearby rock slopes and outcrops as well as quarry studies and test pits provide information about the subsurface with minimal intrusion into the subsurface.

3.5.1 In Situ Rock Measurements

Measurements performed on rock outcrops or rock cores provide valuable information about the rock in a natural state where the geotechnical design will encounter it. In situ rock measurements include measuring the orientation and frequency of discontinuities. The strike and dip of discontinuities within the rock can affect the structural integrity of rock cuts, especially if they are sloping towards the roadway. A detailed description of the rock includes rock type, changes in rock formation, bedding thicknesses, weak zones, as well as the strike and dip of discontinuities, the joint frequency, filling material and groundwater that may be present. Photos can be of assistance as well. Rock mass rating systems such as the RMR system developed by Bieniawski and the GSI system utilize insitu measurements and can provide good analysis of the condition of the rock. Detailed information on the design of rock cuts can be found later in this manual.

Quarry Studies

MnDOT aggregate classes are defined by their rock type. Quarry studies are conducted by the Geology Unit to determine the rock types present within a specific quarry. Requests for studies are generally made by the District Materials Engineer. Studies may be undertaken on an existing quarry when questionable material is produced or when a new quarry is developed. Aggregate classes are given to each quarry using MnDOT specification 3137.

3.5.2 Standard Penetration Test (SPT)

The Standard Penetration Test is the most common in situ test used by Geotechnical Engineers. It was developed in the 1920's as a method of quantitatively measuring the relative densities of soils. The data is used to estimate both strength and stiffness parameters for bearing capacity and settlement analysis of foundations.

Figure 3-3 : Standard Penetration Diagram

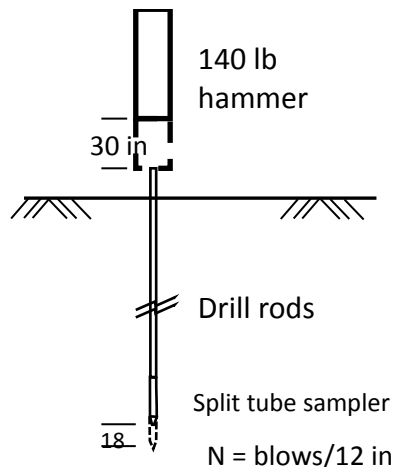

The test equipment consists of a hammer system, drill rods and a sampling device. The test is performed during hollow stem auger or rotary mud drilling operations. To perform the SPT, drill or auger down to the desired test elevation. Be sure the hole is clear of debris and cuttings. Place a sampler at the end of the appropriate length of drill rods. Set the sampler at the bottom of the borehole; avoid dropping the sampler so as to prevent contamination of the sample. Drive the sampler by striking the end of the rod assembly with a hammer system compliant with ASTM D1586-11. Use a hammer weighing 140 lbs and allow it to drop 30 inches, striking the end of the drill rod system. Drive the sampler in 3 consecutive drives of 6 inches, counting the number of blows for each 6 inch drive. End the SPT when:

- the sampler has advanced 18 inches,
- 50 blows have been applied during any one of the three 6 inch increments,
- a total of 100 blows have been applied, or
- there is no observed advance of the sampler for 10 successive blows of the hammer.

The first 6 inch increment during an SPT is considered the 'seating drive'. The total number of blows required to advance the next two drive increments is the standard penetration resistance, N , and can be correlated to the shear strength and bearing resistance of a given soil layer. If the test does not proceed for the full 18 inches, extrapolate the N value from any portion of the last two drives.

The soil or rock collected in the sampler is considered to be a disturbed sample and is suitable for finding moisture content and identification of the soil or rock type. Sample quality is typically not suitable for more advanced laboratory testing.

The SPT has proved to be an extremely valuable test, however, use the N -value measured from the test with caution because of the many inconsistencies introduced into the system from various sources. Figure 3-4 gives an overview of the variables associated with the Standard Penetration Test.

Figure 3-4: SPT Test variables

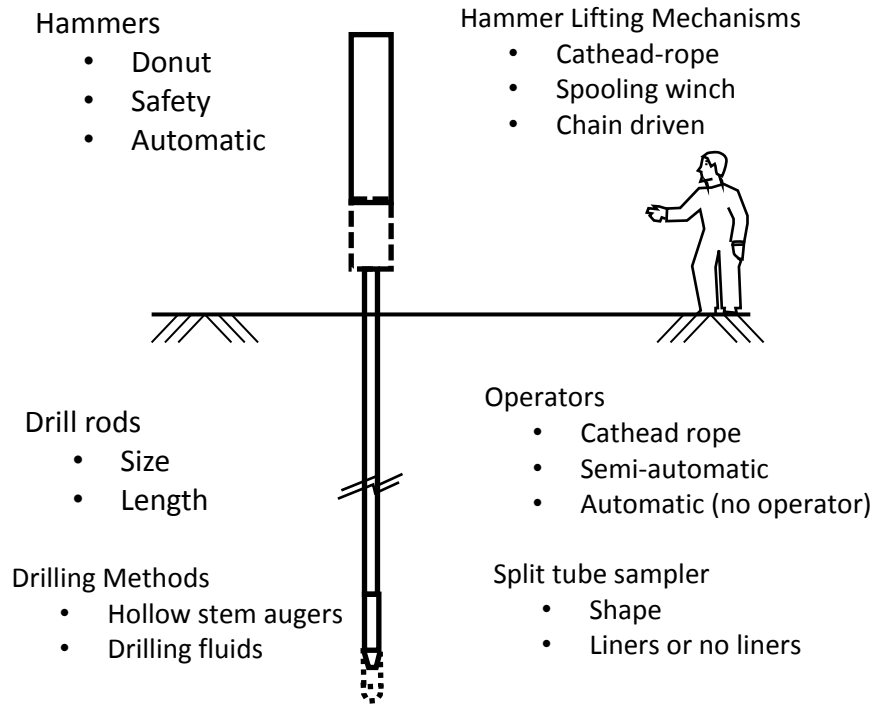

One of the largest sources of inconsistency within the SPT is the variable energy delivered by the hammer system. Beginning in the 1970's, researchers showed that the SPT hammer system delivers less than 100% of the potential energy of the system. The research also showed that the blow count (N value) is inversely proportional to the energy delivered to the drill rods for N values up to 50. The harder a hammer hits the rods, the lower the resulting blows. Because the original SPT data was developed with lower hammer energy efficiencies, researchers in the 1980's proposed that the N value be corrected to reflect improvements in energy transfer. It was estimated that the average energy efficiency of a hammer system when the SPT was developed was about 60%. Therefore, N values were normalized to reflect a 60% energy transfer using a correction factor, C_f . The standardized blow count is referred to as N_{60} .

$$C_f = \frac{\text{Efficiency}_{\text{measured}}}{60}$$

$$N_{60} = N_{\text{measured}} * C_f$$

For example, a hammer system that was measured to be 80% efficient would have a correction factor of $80/60=1.33$.

The Geotechnical Section began testing their SPT hammer systems in 1996. Energy measurements, taken with the Pile Driving Analyzer showed that the hammer systems were delivering between 27-82% of the potential energy of the hammer system. With this new understanding of SPT hammers, the Geotechnical Section decided to

standardize their SPT data by calibrating their hammer systems such that each hammer would provide an average transferred energy efficiency of 60%. This was accomplished by reducing the hammer stroke and/or the height of fall. In addition, it was decided to perform annual energy measurements to verify calibrations and to institute a regular maintenance program to ensure that all hammer systems are working properly.

Informal research by the Geotechnical Section has shown that in certain soil conditions the rod size may also have a significant impact on the measured blow count with similar equipment and soil conditions. The preliminary findings suggest that SPT with N size rods will produce higher blow counts than SPT with A size rods under equivalent conditions.

The correlation between blows per foot and the compactness of granular soils or the consistency of cohesive soils is shown in Table 3-6.

Table 3-6: Typical blow counts for various soil types	
Compactness-Granular Soils	Blows Per Foot (BPF)
Very loose	0-4
Loose	5-10
Medium dense	11-24
Dense	25-50
Very dense	>50
Consistency-Cohesive Soils	Blows Per Foot (BPF)
Very soft	0-1
Soft	2-4
Firm	5-8
Stiff	9-15
Very stiff	16-30
Hard	31-60
Very hard	>60

3.5.3 MnDOT Modified Standard Penetration Test (SPT)

Standard Penetration Test (SPT) and Split-Barrel Sampling of soils will proceed in accordance with ASTM Designation: D 1586-84 (Reapproved 1992) with the following exceptions:

Calibrate the SPT hammer using a PDA analysis type system such that the hammer delivers between 60-70% of the potential energy of the system (2520-2940 in-lbs.) The calibrated hammer blow counts should be denoted as N_{60} on the final boring logs. When calibrating the hammer, perform energy tests at depths greater than 25 feet and in soils with blow counts ranging from 10-50 bpf. Once the hammer has been

calibrated, denote the N values on the boring log as N60 values. Also, clearly note the hammer efficiency and calibration date on the first page of the boring log in the remarks column, i.e. the text will read "SPT hammer calibrated to 65% efficiency on 3/11/2000".

3.5.4 Cone Penetration Test (CPT)

The Cone Penetration Test (CPT) became a regular part of the Geotechnical Section's investigation arsenal in 2001. This in situ test is best suited for accurately defining the subsurface stratigraphy. Data from this test is collected approximately every inch of penetration, which provides a continuous picture of the subsurface conditions. The test is also very consistent and repeatable, with very few variables. In addition, specialized geophysical methods such as resistivity and seismic measurements provide important soil characteristics. Drawbacks consist of the lack of quality samples and limitations with pushing past obstructions.

The Cone Penetration Test, or CPT for short, is an in situ test whereby an instrumented probe is pushed into the ground at a standard rate of 2 cm/sec (about 1 in. per second). While the probe is being pushed, internal sensors measure the soils resistance to penetration at the cone shaped tip and along a six-inch sleeve. In addition, many probes include a sensor located just behind the cone head that measures minute changes in pore water pressure.

The CPT system consists of the instrumented probe (penetrometer), the push system (rig and hydraulics) and the data acquisition system. The penetrometer is comprised of a rod about a meter long and about 1.5 inches in diameter. A 60° conical tip is attached to the free end of the penetrometer. Two standard diameters of penetrometers are available, 1.44 inches and 1.75 inches.

Figure 3-5: Standard CPT Diagram

Standard Piezo-CPT Probe

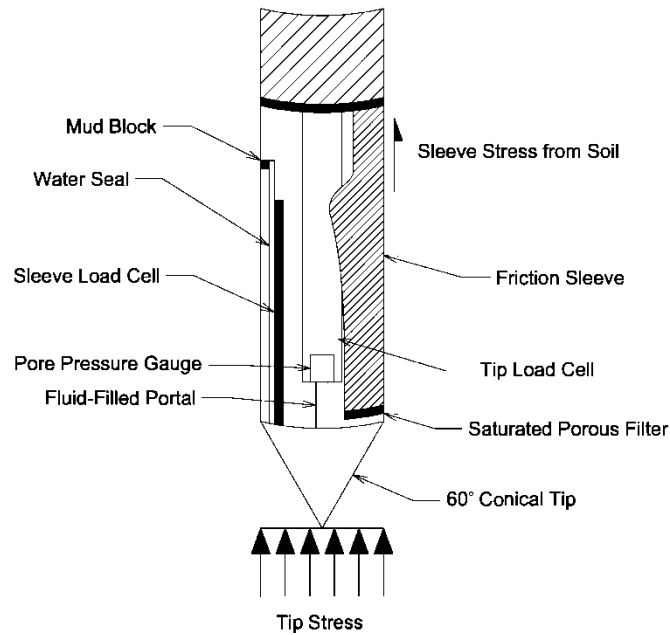

During the CPT, the probe is advanced through the soil layers using a hydraulic push mechanism. The truck or track that the hydraulics is attached to acts as a reaction mass. CPT rigs are usually range between 5-30 tons in weight. The push rods are 1-meter (3.2 ft.) long rods with an outside diameter of 1.44 or 1.75 inches. Connections are made with threaded joints.

A typical CPT plot with is shown in Figure 3-6.

Figure 3-6: Typical CPT plot

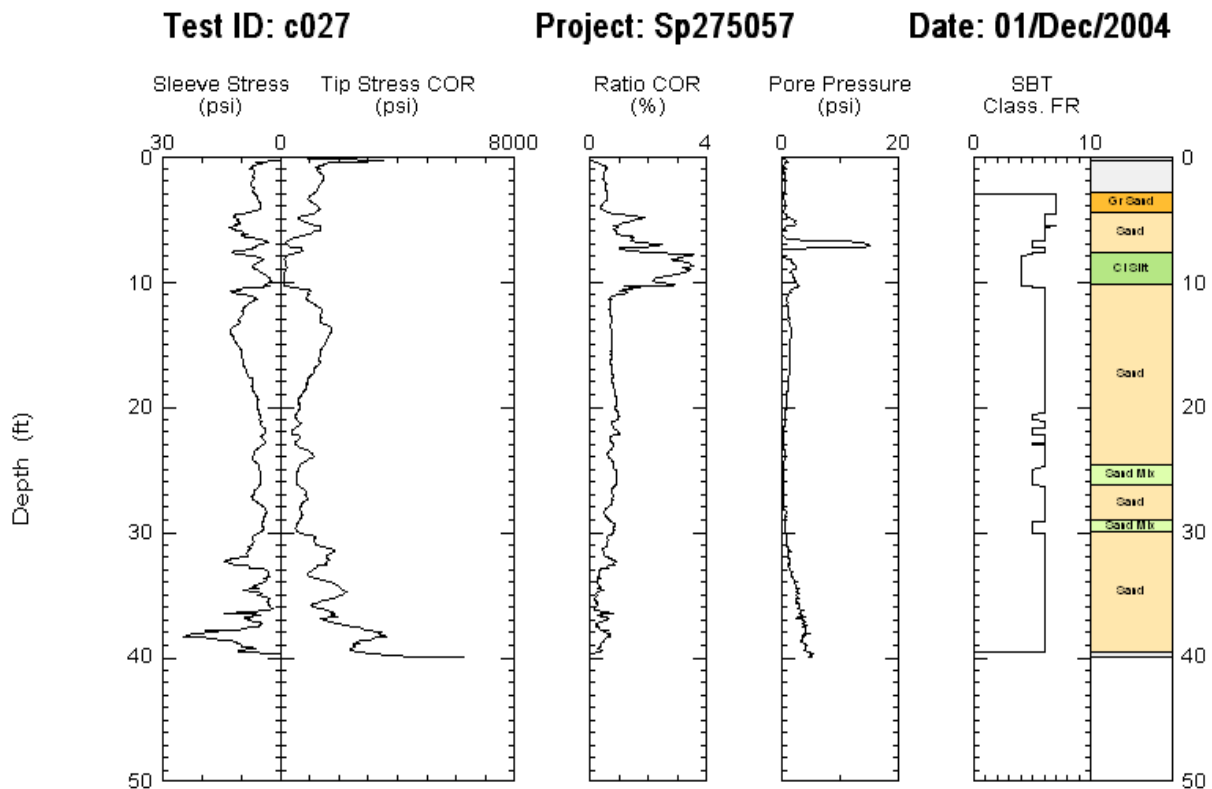

3.5.5 Flat Plate Dilatometer (DMT) (ASTM D6635-01)

The flat plate dilatometer test, also known as the dilatometer test, was introduced by Marchetti in 1975. The DMT consists of a rectangular flat plate that is pushed into the ground, similar to the CPT. In the middle of the blade there is a thin circular steel diaphragm mounted on one side. After the dilatometer is pushed to the test depth, the diaphragm is inflated using gas pressure. Three pressure readings may be read during a DMT. First, the pressure required to start moving the membrane against the soil. Second, the pressure required to move the center of the membrane 1.1 mm against the soil. Finally, corresponding measurements may be made while deflating the membrane. These pressure readings are used to estimate the in situ lateral stress and lateral soil stiffness.

The DMT blade is made of hardened steel and is 3.7 in. (94mm) wide, 9.3 in. (237mm) long and 0.55 in. (14mm) thick. The circular diaphragm is made of stainless steel and is mounted to one side of the blade.

Dilatometer tests are performed at 8 to 12 inch intervals, thus providing an almost continuous profile of the soil response. The test may be used in a wide range of soils including dense sands, very soft clays, and organic soils.

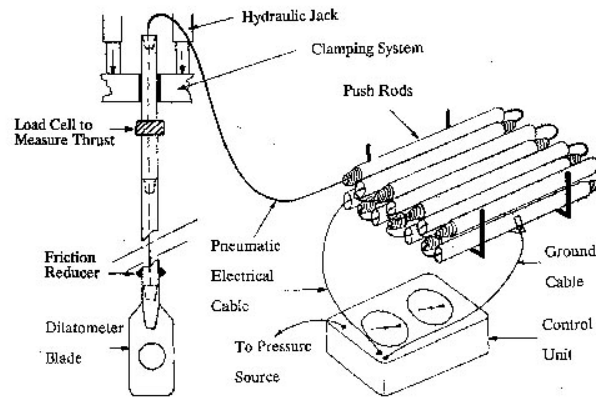
Figure 3-7: Flat Plate Dilatometer (from FHWA-SA-91-044)

3.5.6 Pressuremeter Test (PMT) (ASTM D4719)

The Pressuremeter Test is a method to assess lateral earth pressure in-situ generally by use of a cylindrical probe lowered into a borehole. The probe is pressurized, inflating a flexible membrane, such that the probe device expands makes intimate contact with the surrounding soil. The relationship of the borehole deformation in response to the applied pressure is of interest. An up-hole gas pressure application system, connection tubing, support cabling, and readout device complete the system. There are also self-boring and CPT based pressuremeter systems, although these are somewhat less common. 'Menard' and 'TEXAM' are two common pressuremeter systems.

The test is frequently used to measure the in situ stress/strain behavior of site soils and rock to gain an understanding of stiffness and 'pressuremeter modulus' for engineering calculations where soil deformations are important. One application is predicting settlement of shallow foundations using the pressuremeter modulus. Stress controlled and strain controlled tests are available. Cyclic and creep testing is available with the system. There are different methods for interpreting the results and inferring material properties from pressuremeter testing. Some methods rely on empirical correlations and others use more rigorous cavity expansion theories. The PMT, like the DMT, is a valuable tool for lateral load analysis.

The geotechnical section has a TEXAM pressuremeter; historically it has been primarily used for work in soft rock. The test requires a high quality borehole and good drilling practices with "greater than typical care" are to be exercised when drilling PMT holes to promote acquisition of good test data. The probe membranes are subject to puncture and failure if borehole surfaces are very rough or uneven. Straight boreholes improve the ease of insertion and retraction of the probe considerably. Frequently, due to the

complexities of the test, this work is contracted to consultants who perform the work on a more regular basis. Pressuremeter testing (PMT) is to be conducted in accordance with ASTM Designation D 4719.

Corrected pressure-volume data is to be presented in graphical format with supporting field data provided in tabular format. The FHWA-IP-89-008 manual entitled “The Pressuremeter Test for Highway Applications” should also be reviewed before field PMT work is performed on a project. Field records of the necessary test calibrations and test data must be recorded and transmitted. A final foundation boring log indicating the depth(s) of the PMT testing is to be prepared.

When consultants are performing the work, this information is to be submitted to the State’s Geotechnical Section (Maplewood Lab). The electronic file is to be compatible with Bentley gINT© and should match the format used by the MnDOT Geotechnical Section.

Figure 3-8 Pressuremeter testing being performed to assess soil conditions for the Glen Road Interchange Project on US10/US61 in Newport, MN



3.5.7 Test Pits

In areas that are inaccessible to the drill rig, backhoe-dug test pits may be used for shallow soil exploration. Test pits may also be used in pavement areas, in lieu of cores, to obtain a larger sample of the base and subbase aggregates. The excavated test pit should be backfilled with the cuttings or other suitable fill material, compacted in relatively thin lifts; and, in the case of test pits dug through existing pavements; the roadway should be properly patched.

3.5.8 Geophysical Methods

Geophysics is the application of physics to the investigation of the earth. Engineering geophysics can be defined as the use of geophysical methods to conduct subsurface investigations for engineering applications. Several different methods of geophysical testing are useful for gathering geotechnical information. Geophysical investigations assist in highway design, construction, during maintenance and repair of transportation

systems. In the geotechnical realm, geophysical methods are valuable in mapping the subsurface, including determining the depth to bedrock, the bedrock quality, subsurface soil stratigraphy and various soil and rock properties; investigating roadway subsidence; and imaging buried man-made features. At MnDOT geophysical applications have been used to delineate:

- Subsurface soil/rock stratigraphy
- Presence and location of organic deposits
- Bedrock assessment - including depth and topography
- Cavity detection - karst and underground abandoned mines
- Sulfide assessment
- Sand & Gravel prospecting
- Slope failure assessment
- Underwater surveying

Geophysical methods include electrical methods (i.e. resistivity), seismic methods, electromagnetic methods, and gravity methods. Currently the Geology Unit utilizes electrical and seismic methods. Advantages of using geophysics in geotechnical subsurface investigations are many, including the ability to collect data over large areas in a relatively short period of time and go where conventional methods such as drilling were previously not able to do so; such as areas where drilling could cause environmental risk. Although each method can be utilized for transportation concerns, they may not be appropriate for every situation. For all geophysical methods, correlation with a drilling program or other subsurface geologic data is highly recommended. Geophysical methods are an asset to a conventional drilling program; they can pinpoint areas of concern as well as “fill in the gaps” between borings. A brief summary of a few of the most commonly used geophysical survey techniques is provided below. See the “Application of Geophysical Methods to Highway Related Problems” FHWA-IF-04-021 for detailed information.

The role that geophysical applications play in geotechnical investigations is varied and can be implemented at any phase of the project as follows.

1. Pre-Design/Scoping Phase-reconnaissance, prevention of construction cost over runs
2. Preliminary Design Phase- supplement other data, guidance for other investigations methods, or to ‘fill in the gaps’ between other methods
3. Construction Phase-investigate unexpected subsurface conditions
4. Failures-assist in failure assessments
5. Special circumstances-acquire information where other methods are prohibited or are extremely difficult to use.

Geophysical investigations are performed by the Geology Unit and the suitability of each method is evaluated on a case-by-case basis.

Electrical Resistivity Imaging

The Geology Unit has expertise utilizing electrical geophysical methods. **Electrical resistivity imaging (ERI)** utilizes a property of subsurface materials called “resistivity”. Resistivity describes the ability of a particular material to impede the flow of electrical current. Surveys are performed by injecting current into the ground using two electrodes and measuring the potential difference using other electrodes also implanted in the ground. The Geology Unit has capabilities to perform 1D, 2D, and 3D resistivity imaging. Surveys conducted by the Geology Unit are generally either 2D, oriented in a line of 56 or more electrodes, or 3D, which is laid out in a regular grid. Upgrades in technology and software have made the method much less labor intensive than in the past.

Electrical resistivity imaging is a highly useful method that can be performed in a wide range of terrain and soil types to detect subsurface cavities (i.e. sink holes or other subsidence), to map bedrock or groundwater table as well as to delineate change in subsurface soil stratigraphy. Recently, this method has been used extensively at MnDOT to map the bedrock surface, determine depth and extent of organic deposits, locate subsidence and subsidence potential areas, and investigate geofoam construction. As with all geophysical methods, resistivity imaging can only be successful when a *contrast* of the specific geophysical property, in this case resistivity, exists between material types. The method can be labor intensive and takes time to complete a survey once set up, but with appropriate software and a field laptop, results can be viewed immediately. Geophysical results should be interpreted by someone familiar with the site geology and correlated with a drilling program if possible.

Seismic Methods (Refraction & MASW)

Seismic geophysical methods are commonly conducted for transportation engineering applications. These methods measure how seismic waves travel through the subsurface to determine the physical properties of the soil and rock. This information is used to create a picture of the subsurface based on geologic knowledge and lithological properties. Seismic geophysical methods are useful in determining much of the general subsurface information required for transportation such as bedrock topography, lithology, and depth to the water table. Seismic methods commonly conducted include **Seismic refraction, seismic reflection, and surface wave methods**. Each employ similar techniques; a source of seismic disturbance, such as a hammer striking the ground or a rifle shot, is introduced into the ground, the waves created are measured by geophones placed in the ground at specific locations to measure the desired target (i.e. bedrock surface). The advantages of seismic methods are that they can be used in many different types of terrain and different soil conditions and they are able to determine depth to bedrock and lithology. Though they are relatively quick to run, data processing can take time and requires geologic knowledge and expertise. Seismic noise in urban settings can also be an issue especially for refraction surveys. The Geology Unit currently utilizes refraction and multi-channel analysis of surface waves (MASW).

Seismic Refraction is generally performed by the Geology Unit to determine depth to bedrock and bedrock topography. The Geology Unit has the capability to collect data with a setup of 24 or 48 geophones. A hammer strike provides the seismic signal and the geophones record the waveform for a given amount of time once the instrument is triggered. The hammer strike is repeated at various locations along the line as necessary for the investigation. Processing is done in the office and layer models or refraction tomography can be created for the location.

The Geology Unit performs **MASW** for various applications throughout the state. MASW is used to evaluate the stiffness of the subsurface. MASW has several advantages in that it can be conducted fairly rapidly, especially with the use of landstreamers and a repeatable source such as a seismic hammer mounted on the back of a truck, although it can also be performed conventionally by the use of a heavy sledge hammer and MASW also can be conducted on roadway surfaces. After processing, an image of the shear wave velocity of the subsurface is produced from which properties of the subsurface materials can be inferred. Underground mine voids, void/sinkhole mapping, and subsurface investigations are among the applications where MASW can be used.

Ground Penetrating Radar

Ground Penetrating Radar (GPR) uses electromagnetic pulses in high frequencies transmitted from a radar antenna to image the subsurface. GPR is especially useful to image near surface targets such as the location of pipes and tanks, pavement characteristics, and top of the water table. The effectiveness of GPR decreases in the presence of water and soils with high percentage of clays. GPR has the advantage that despite many site limitations, the surveys are quick and easy to run and data can be viewed in real-time. GPR methods are currently conducted by MnDOT's Research Section.

3.6 Groundwater Investigations

Estimate ground water levels at the investigation site prior to drilling. Estimates can be based on USGS Topographic maps, previous experience in the area or from hydrogeologic publications by the MGS or DNR. Previous experience and geologic judgment will help to determine if groundwater will be an issue in a particular area or in particular soil types. If initial estimates indicate that groundwater is expected to have an adverse effect on the construction or the life of the project, a groundwater investigation should be conducted. Among other effects, groundwater can negatively impact slope stability and pavement performance (FHWA-TS-80-224). A groundwater investigation often includes geologic studies, SPT drilling and sampling, CPTs, installation of piezometers, lab testing, and **permeability analysis**. In-situ testing may also be used for a more reliable measure of the permeability of site soils, although this testing is frequently more complicated and expensive than extracting material samples and performing laboratory tests.

3.6.1 Borings & Soundings

Record the soil moisture condition and, when evident, groundwater levels on the drilling log. Note changes in soil type, such as from granular material to clay, because these changes may indicate a confining layer within an aquifer. These are however; only a moment-in-time picture of the water levels. In order to assess water levels at the site, further study is necessary. Properly label and store soil samples gathered for required laboratory testing. CPT data shows the changes in soil type and provides valuable information about soil.

3.6.2 Piezometers

Once water levels are deemed high enough to interact with construction, install a series of piezometers to monitor groundwater levels. A minimum of three piezometers should be installed into the aquifer. Three piezometers allow the calculation of both flow direction and the elevation of the groundwater table. Monitor piezometers for at least a year, but preferably longer to provide a long-term picture of groundwater level fluctuation with seasons and climatic conditions if any.

3.6.3 In-Situ Testing

In-situ field testing for aquifer characteristics should also be performed. These tests assist in the design of a drainage system. They may include conducting **slug tests**. A slug test performed by introducing a known volume of water into a monitoring well and the rate at which the water level falls is measured. Advantages to conducting slug tests include the ease and quick measurement time. The slug test has a disadvantage; the small size of the test may only represent the characteristics of the aquifer very near the well. Generally, this information is enough to determine the aquifer properties. **Pump tests** may also be performed. A pump test is performed by pumping a well for a period of time and noting how the hydraulic head changes in the aquifer over time. A priori knowledge of the geologic setting is important when conducting pump tests to correctly select the proper analysis procedure. Laboratory testing on soils is also beneficial in calculating aquifer properties.

Permeability analyses should also be conducted from the test data. These are discussed in detail in Chapter 6.

Geophysical testing may also be performed. In conjunction with borings, this data can provide a seamless image of the subsurface including the groundwater table. Techniques such as **Earth Resistivity Imaging** (ERI) can be employed for this purpose. Geophysical methods are discussed in detail in Section 3.5.8.



Chapter 4

4 Laboratory Testing

The Foundations Lab performs laboratory tests on soil and rock samples to ascertain the nature, strength, and consolidation characteristics of the materials existing at the site.

4.1 Minimum Testing Rates

The following table shows the minimum number and lab tests to be performed for each sample type. Additional lab tests may be required to determine additional soil properties such as strength, compressibility, and permeability.

Sample Type	Minimum Required Lab Tests
Thin Wall	One (1) unconfined compression test One (1) moisture test One (1) unit weight determination
Split-Tube	One (1) moisture test
CPT sample	One (1) moisture test

4.2 Moisture Content Tests

Laboratory determination of moisture content of soil will proceed in accordance with AASHTO T265-93. The moisture content will be determined for every sample procured by the test boring program, except wash samples and tailings.

4.3 Unconfined Compression Tests

Unconfined Compressive Strength of Cohesive Soil will proceed in accordance with AASHTO T208-92, with the following exceptions:

- Specimens will have a minimum diameter of 2.8 inches.
- Humidity Room and Vertical Lathe will not be required.
- Specimens will be free of tailings, seams, cracks and other characteristics that will affect the strength value obtained. No specimens will be obtained from the upper 6 inches of thin-walled sample or from areas of noticeable disturbance caused by the sampling operation.
- Testing remolded specimens will not be required.
- Testing by the Controlled Stress Method will not be required.
- Preparing a load-strain graph will not be required.
- Unconfined compressive strength will be determined from the maximum load value obtained or the load at 15 percent strain, whichever is secured first.

A minimum of one **unconfined compression test** will be conducted on each thin-walled sample of cohesive soil insofar that sufficient undisturbed specimens are obtained. An undisturbed residual portion of each sample not used in performance of the unconfined compression test will be retained and stored for future consolidation or triaxial tests or for rechecking purposes. Residual samples will be sealed, packaged and stored to preserve their original condition.

4.4 One Dimensional Consolidation Tests

One-dimensional consolidation properties of soils will proceed in accordance with AASHTO T216-94. The choosing of samples for consolidation testing will be at the discretion of the Consultant except that the samples will be selectively chosen to represent major compressible soil strata on the overall project. Consolidation testing will not be performed 1) when the natural moisture content of the soils are near the plastic limit, 2) on soft soils near the ground surface (depth less than 10 feet) which will be excavated, and 3) when the proposed additional loading is 0.25 tons or less.

4.5 Triaxial Compression Tests

Strength Parameters of Soils by Triaxial Compression will proceed in accordance with AASHTO T297-94, consolidated undrained method with pore water pressure measurement. The choosing of samples for triaxial testing will be at the discretion of the engineer. Three different consolidation pressures will be used to define a failure envelope. When Mohr's circles have been plotted and a line cannot be constructed tangent to three circles, an additional test will be performed at increased consolidation pressure. Triaxial testing will not be performed on soft soils near the ground surface (depth less than 10 feet) that will be excavated.

4.6 Unit Weight Tests

The moist unit weight will be determined in conjunction with unconfined compression and triaxial compression tests.

4.7 Specific Gravity

Specific Gravity of Soils will proceed in accordance with AASHTO T100-95. The specific gravity of soils will be determined in conjunction with consolidation tests.

4.8 Engineering Properties

This section discusses the soil properties of principal interest for analysis and design of highway subgrades/embankments and pavement structures.

4.8.1 Atterberg Limit Tests

The engineering properties of fine-grained soils vary with the amount of water present. As the water content changes, the consistency of these soils will also change as the material passes through the various physical states (namely liquid, plastic, semisolid, solid).

In 1911, A. Atterberg established limiting water contents for the different physical states/engineering behaviors. These limits are known as the Atterberg limits and consist of the liquid limit, the plastic limit and the shrinkage limit. The Atterberg limits are water contents (expressed as percentages) where the soil behavior changes. A description of the various states, limits, and indices is shown in Figure 4-1.

Above the liquid limit, LL, the soil-water system is a suspension. Below the liquid-limit and above the plastic limit, PL, the soil-water system is said to be in a plastic state. In this state the soil may be deformed or remolded without the formation of cracks and without change in volume. The range of water content over which the soil-water system acts as a plastic material is frequently referred to as the plastic range, and the number difference is called the plastic index, PI:

$$\text{Plastic Index PI} = \text{LL} - \text{PL}$$

Somewhat below the plastic limit, the soil-water system reaches the shrinkage limit, SL. Reduction of the water content by drying below the shrinkage limit is not accompanied by a decrease in volume; instead air enters the voids of the system and the material become unsaturated.

The Atterberg limits vary with the amount of clay present in a soil, the type of clay mineral, and the nature of the ions absorbed on the clay surface.

The most common use of the Atterberg test results is for soil classification. Soils with comparable limits and indices are classed together. The number is used to classify fine-grained soils and the indices to characterize soil behavior.

Generally, soils with high liquid limits are clays with poor engineering properties. A low plasticity index indicates a soil with little or no cohesion and plasticity, such as a granular type soil. Both the liquid limit and plasticity index are used to some degree as a quality-measuring device for pavement materials.

Figure 4-1: Atterberg Limits Relationships

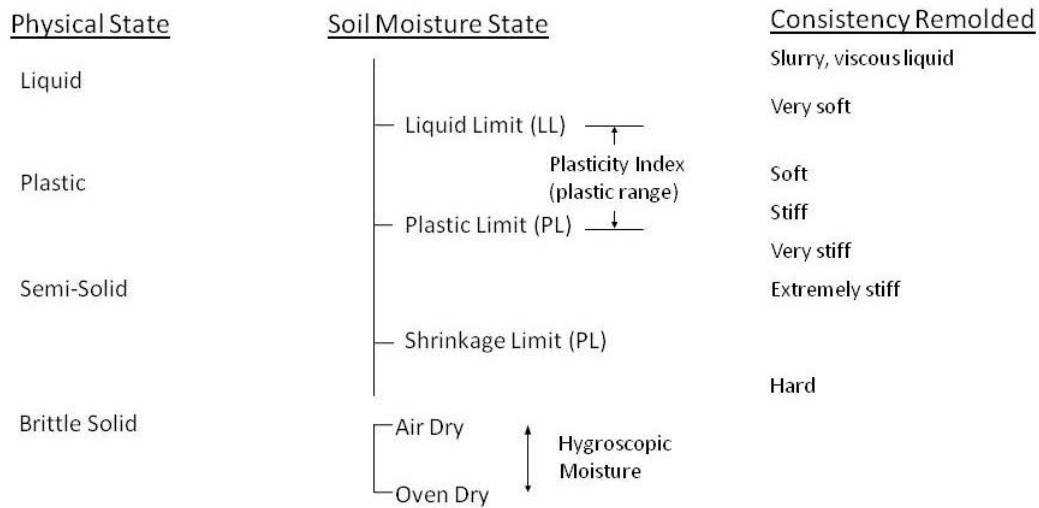

Liquid Limit of soils will proceed in accordance with AASHTO T89-96. The Liquid Limit will be determined for cohesive soils with N_{60} values of less than 15 and not to exceed two Liquid Limit tests per bore hole. The choosing of samples for Liquid Limit tests will be at the discretion of the Engineer, except that the samples will represent major soil strata on the overall project. Plastic Limit and Plasticity Index of Soils will proceed in accordance with AASHTO T90-96. The Plastic Limit and Plastic Index will, be determined for all samples that are tested for Liquid Limit.

4.8.2 In-place Volume and Weight Relationships

In-place soil is comprised of a mixture of soil solids, water, and air. The relative proportion of each of these constituents determines many of the properties of the soil. A soil block diagram, with symbols for each of its volume and mass components, is shown in Figure 4-2.

Figure 4-2: Volume and weight relationships for a soil

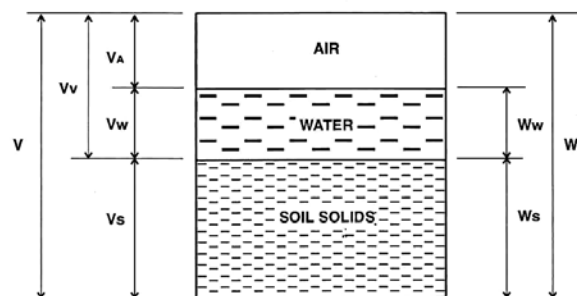

The moisture content is the ratio of the weight of water to that of the dry soil solids, expressed as a percent; and is determined as follows.

$$w = \frac{W_w}{W_s} * 100$$

w = moisture content, %;
 W_s = dry weight of solids, g
 W_w = weight of water, g

The porosity is the ratio of the volume of voids to the total volume and may be expressed as either a percent or decimal; and is determined as follows.

$$n = \frac{V_v}{V}$$

n = porosity;
 V_v = volume of voids, cm^3
 V = total volume, cm^3

The degree of saturation is the ratio of the volume of water to the total volume of voids, expressed as a percent; and is determined as follows.

$$S = \frac{V_w}{V_v} * 100$$

S = saturation, %;
 V_w = volume of water, cm^3
 V_v = volume of voids, cm^3

The void ratio is the ratio of volume of voids to volume of solids and may be expressed as a percent or decimal; and is determined as follows.

$$e = \frac{V_v}{V_s} * 100$$

e = void ratio;
 V_v = volume of voids, cm^3 ; and
 V_s = volume of solids, cm^3 .

The density, or unit weight, of the soil mass is further divided into moist density and dry density. Moist density is the weight of water and soil solids divided by the volume of the soil mass. Dry density is the weight of only the soil solids divided by the volume of the soil mass. These values are determined by the following formulas.

$$Y_m = \frac{W_w + W_s}{V}$$

Y_m =moist density, pcf;
 W_s =weight of solids, lbs
 W_w =weight of water, lbs
 V =total volume, ft³

$$Y_d = \frac{Y_m}{1 + \frac{w}{100}}$$

or,

$$Y_d = \frac{W_s}{V}$$

Y_d = dry density, pcf;
 Y_m = moist density, pcf;
 W_s = weight of solids, lbs
 w = moisture content, %
 V = total volume, ft³

The density of the soil mass affects the strength of the soil. Generally, as the dry density increases, the strength increases. In addition, the potential for the soil to take on water later is decreased by higher densities. This is due to the decreased presence of air space in the soil mass.

The in-place moisture content of a soil can often be used, along with the soil classification, to determine the suitability of the material as a subgrade. Generally, as the moisture content of a soil increases its strength decreases. This is further illustrated by comparing the moisture content of the soil with its Atterberg Limits. For example, if the natural moisture content is near the liquid limit, the soil will quickly be disturbed by earth moving equipment and is unlikely to be suitable subgrade material. On the other hand, natural moisture content below the plastic limit indicates a relatively firm material, which, provided additional moisture is not added, could provide a suitable subgrade. The moisture content of a soil should be expected to vary somewhat with the seasons and with rainfall.

4.8.3 Grain Size Analysis

Particle-size analysis of soils will proceed in accordance with AASHTO T88-93. The particle-size analysis will be determined for all samples that are tested for Liquid Limit.

4.8.4 Organic Content Tests

Organic Matter Content of Soils will proceed in accordance with AASHTO T267-86. The choosing of samples for organic matter content will be at the discretion of the Consultant. Samples for organic matter testing will be selectively chosen to represent major soil strata on the overall project that are black in color or described as organic.

4.8.5 Unconfined Compression Tests for Rock

Rock strength can be defined as the stress required to generate significant permanent deformation. It is an important component of all geotechnical designs dealing with rock.

Unconfined Compression Strength testing provides a way to determine rock strength at a specific location or depth within a boring. Rock core specimens are prepared for testing using the methods described in ASTM D4543-04. Specimens must have a length of 2.0 to 2.5 times the diameter. After cutting, end surface grinding and a flat surface are used to prepare the sample to within the allowable limits. Rock core samples are testing according to ASTM D2938-95. The rock specimen is placed in an appropriate loading frame where the axial load continually increases until failure occurs. Pictures or drawings are taken before and after strength testing. Moisture condition at the time of test is also recorded. Rock strength values are calculated using the following equation:

$$\sigma = \frac{P}{A} \quad \text{Where } \sigma = \text{Compressive Strength}$$

P=Maximum Load
A= cross sectional area

Unconfined compressive strength values are also determined from the stress/strain chart produced by the software used during testing. The tester records the unconfined compressive strengths on the gINT log and on a database kept by the Geology Unit. Any other information calculated is also placed on the logs using gINT.

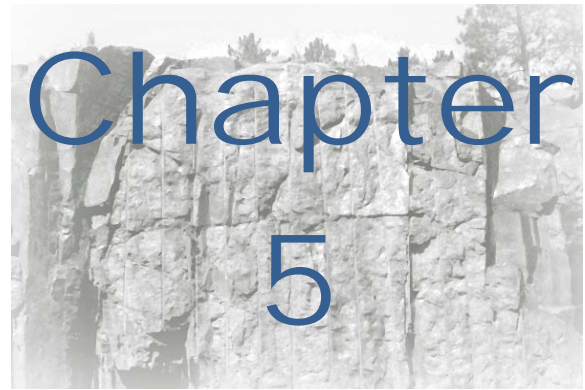

5 Soil & Rock Classification and Logging

It is important to distinguish between visual identification and classification of soils. Soil *identification* is based on a visual-manual procedure for identifying the soil while soil *classification* is the grouping of soils with similar engineering properties based on a more precise laboratory evaluation supported by index tests. For the most part, The MnDOT Geotechnical Section describes soils based on a visual-manual procedure. Index tests are run on select samples to verify or refine the procedure. The soil is initially identified in the field, however due to sampling procedures; only a small portion of the sample is seen until it is opened in the laboratory where a more detailed identification is done. MnDOT currently uses a textural identification system described below.

5.1 Field Identification

Identification of soil types in the field, which is typically limited to defining the color and estimating the basic characteristics of texture and plasticity, is normally done without the benefit of major equipment, supplies, or time. It is necessary for a general assessment of sites during field reconnaissance activities and during the initial phases of more detailed work, such as the investigation of an emergency remediation or a planned geotechnical or pavement survey. It may, in some instances, be the only effort ever expended towards describing the encountered soils, but in most cases, it will serve as an aid in assigning more detailed or elaborate laboratory tests.

With increased experience, field personnel should become more competent and skilled in accurately identifying the encountered soils, based solely on field techniques. Regardless of experience level, however, laboratory testing should be performed whenever possible to validate and sharpen the field technician's ability.

5.1.1 Texture

The following methods may be used in the field to estimate the soil's texture, which is defined as the relative size and proportion of the individual soil particles or grains in a given soil type.

Visual Examination

By carefully looking at the soil, it can be divided into at least its gravel, sand, and fines (silt and clay combined) components. Since the naked eye can only distinguish particle sizes down to about 0.05 mm (0.002 in.), silt- and clay-sized particles cannot be separated without further magnification.

The examination is done by drying a sample, spreading it on a flat surface, and then simply segregating it into its various components and estimating the relative percentage of each. The percentage refers to the dry weight of each soil fraction, as compared to the dry weight of the original sample. Table 5-1 provides the defined particle sizes for each component and a common reference to aid in identifying the various particle sizes.

Table 5-1: Visual Identification		
	Approximate sieve size limits	
<i>Classification</i>	<i>mm</i>	<i>sieve</i>
Boulder	>254	
Cobble	75-254	3 in.
Coarse Gravel	25 - 75	3 in. to 1 in.
Medium Gravel	9.5 – 25	1 in. to 3/8 in.
Fine Gravel	2.0 - 9.5	3/8 in. to No. 10
Coarse Sand	0.42-2.0	No. 10 – No. 40
Fine Sand	0.075-0.72	No. 40 – No. 200
Silt and Clay	<0.075	<No. 200

Sedimentation/Dispersion

This test is done by shaking a portion of the sample into a jar of water and allowing the material to settle. The material will settle in layers. The gravel and coarse sand will settle almost immediately, the fine sand within about a minute, the silt requiring as much as about an hour, and the clay remaining in suspension indefinitely. The percentage of each component is estimated by comparing the relative thickness of each of the layers in the bottom of the jar, keeping in mind that the larger sized particles will typically settle into a denser mass than the fines.

Plasticity

The ability to be molded within a certain range of moisture contents is termed plasticity. It is dependent upon the percentage and type of clay component, and it therefore requires differentiation between silt (non-plastic fines) and clay (plastic fines). The following methods can be used in the field for this differentiation. These methods are performed on minus No. 40 (0.425 mm) sieve size particles, approximately 1/64 in. (0.4 mm). For a rough estimate simply remove by hand the coarse particles that interfere with the tests.

Ribbon/Thread

In the ribbon/thread test, a roll of soil, moist enough to have workability, approximately 12 to 19 mm (0.5 to 0.75 in.) in diameter and about 75 to 125 mm (3 to 5 in.) long, is pressed between the thumb and index finger into a ribbon about 3 mm (0.125 in.) thick. The longer the ribbon can be formed before the soil breaks under its own weight, the higher the soil's plasticity. Highly plastic clays can be ribboned to perhaps 100 mm (4 in.) longer than their original cast. Clays of low plasticity can be ribboned only with some difficulty into short lengths, while non-plastic materials cannot be ribboned at all. A chart including the MnDOT Textural Triangle as well as the length of ribbon for each classification is shown in Figure 5-1.

Figure 5-1: MnDOT Triangular Textural Classification

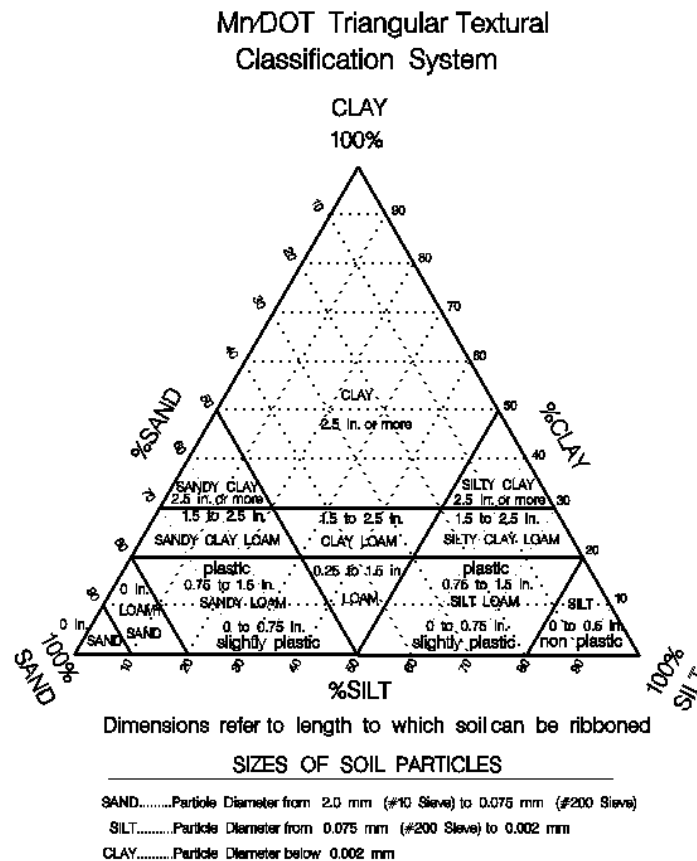

Dry Strength/Breaking

The dry strength/breaking test is normally made on a dry pat of soil about 0.5 in. (12 mm) thick and about 1.25 in. (30 mm) in diameter that has been allowed to air dry completely. Attempts are made to break the pat between the thumb and fingers, with very highly plastic clays being resistant to breakage or powdering and highly plastic clays being broken with great effort. Caution must be exercised with highly plastic clays to distinguish between shrinkage cracks, which are common in such soils, and a fresh break. Clays of low plasticity can be broken and powdered with increasing ease. Silt soil types possess only very slight dry strength. Silty fine sands and silts have about the same slight dry strength but can be distinguished by the feel under powdering the dried specimen. Fine sand feels gritty whereas typical silt has the smooth feel of flour.

Shaking/Dilatency

In the shaking/dilatency test, a pat of soil with a volume of about 8 cubic centimeters (0.5 cubic inch) is moistened to a putty-like state and placed in the palm of the hand. The hand is then shaken vigorously or jarred on a table or other firm object. If the sample's surface begins to glisten, it is an indication that moisture within the sample has risen to the surface. When this does not occur, the soil is probably clayey. Where this occurs sluggishly or slowly, the soil is predominantly silty, perhaps with a small amount of clay. For silts or very fine sands, the moisture will rise to the surface rapidly, and the test can be repeated over and over by simply remolding and then reshaking the pat.

Triangular Textural Classification

This classification system is totally dependent upon its grain-size distribution and is discussed more fully later in this section. However, the soil's classification can be reasonably estimated by determining its plasticity by any of the above methods. Table 4-2 shows the probable classification, based on plasticity, and in particular relates the classification to the results of the ribbon/thread test as performed by the Department.

Quantitatively, a soil's plasticity is defined by its Atterberg limits, which are discussed above.

Organic Content

Generally, a sample can be adequately classified relative to organic content based on smell and feel. If it has a distinctive, musty, slightly offensive, or foul odor, which is enhanced in fresh samples or when exposed to heat; or if the sample has the feel of fresh to decomposed vegetable matter, it is generally organic. Organic soils are generally undesirable in the highway subgrade and are most often excavated and wasted.

5.1.2 Laboratory Testing

In order to assign the proper classification to a soil, the texture (sieve and hydrometer analyses), and the general organic content of the sample are required. These properties can be estimated in the field, as described above; or they can be developed more precisely through laboratory testing at the district level.

The amount of testing to be performed depends upon the complexity of the stratigraphy, the experience level of the field personnel describing the obtained samples, and other factors. Obviously, the more complex the stratigraphy or the less experienced the technician, the more the need for laboratory testing to adequately describe the encountered conditions and verify the field classifications.

5.2 Classification Systems

The purpose of any classification system is to categorize soils by relating their appearance and behavior with previously established and documented engineering properties and performance. Simplicity of the classification system; reproducibility of the sample's classification at different times, locations, and by different field personnel; and applicability to all soils likely to be encountered are all attributes of a good classification system. The system of choice should make distinctions of practical importance to local designs and problems expected.

MnDOT has historically used a textural triangle as its primary soil classification system. The MnDOT Geotechnical Section is moving towards using the Unified Soil Classification System (USCS) and will be showing dual classifications on boring logs while transitioning to USCS.

5.2.1 Triangular Textural

Textural systems of classification, based solely on the soil's texture or grain size distribution, have been developed by a variety of engineers and agencies since the earliest days of soil mechanics. Such systems include those developed by the Bureau of Soils (1890-95), Atterberg (1911), MIT (1931), and the U.S. Department of Agriculture (1938). This latter system is still in use and has been slightly modified by several highway departments, including MnDOT, to better differentiate between local soils.

The following procedure is used to categorize a soil using MnDOT's triangular textural classification system. First, the sample's composition, by percentage of each of the following components, must be determined. **Sand** is between ½ in. (2.0 mm or No. 10 sieve) and 0.002 in. (0.075 mm or No. 200 sieve) in size; **silt** is between 0.002 in. (0.075 mm) and 0.005 in. (0.002 mm) in size; and **clay** is smaller than 0.005 in. (0.002 mm or two microns) in size. Gravel and larger stones (larger than ½ in or 2.0 mm) are disregarded. Then, each of the three axes of the diagram shown in Figure 5-2 are entered with the percent of sand, silt, and clay. Finally, the soil classification is determined by locating the common point of intersection.

In addition to the eleven possible classifications shown on Figure 5-2, **gravel**, defined as smaller than three inches in diameter and larger than 2.0 millimeters in size, is an acceptable classification. Any sample with more than about 25 percent gravel should include the term "gravelly" as a descriptor. Other modifiers to the textural classification should be used with restraint, but are permissible if the result of their use is clear and beneficial. Soils with more than 2% organic content are classified based on methods described in Table 5-2.

Figure 5-2: Triangular Textural Classification

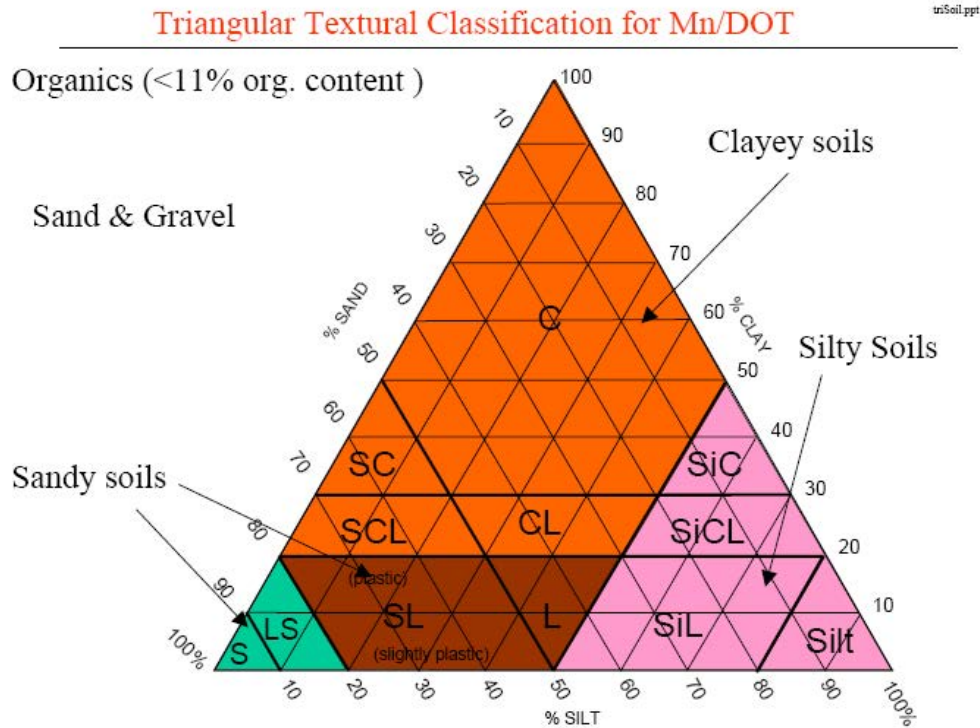

Three examples of obtaining the proper classification of a soil using the triangular textural classification chart are given below:

Example 1: Given a soil sample with 18% sand, 58% silt, and 24% clay, what is its classification?

Entering the left axis at 18%, the bottom axis at 58%, and the right axis at 24%, and moving to the intersection point, the soil's classification is Silty Clay Loam.

Example 2: Given a soil sample with 47% sand, 32% silt, and 21% clay, what is its classification?

Entering the left axis at 47%, the bottom axis at 32%, and the right axis at 21%, and moving to the intersection point, the soil's classification is Clay Loam.

Example 3: Given a soil sample with 32% gravel, 38% sand, 22% silt, and 8% clay, what is its classification?

Soil particles represent 68% of the sample so the sand, silt, and clay percentages must be normalized. The chart is entered with 56% sand (38 divided by 0.68), 32% silt (22 divided by 0.68), and 12% clay (8 divided by 0.68). The soil's classification is sandy

loam. Since more than 25% of the soil sample is gravel, the term "gravelly" is added to the description, resulting in a classification of Gravelly Sandy Loam.

Brief descriptions of each of the acceptable classifications are summarized as follows:

Gravel

Gravel consists of stones that will be smaller than 3 in. and are retained on the No. 10 sieve. Fine Gravel falls between the 9.5 mm (3/8 in.) and 2mm (No. 10) sieves. Coarse Gravel is larger than one in. but smaller than three inches. These materials can be classified by visual inspection.

Sand

Sand is loose and granular; the grains can be seen with the naked eye and can be felt. 100% of this material will pass a 2 mm (No. 10) sieve and will have less than 10% silt and clay combined. It will not form a ribbon.

Coarse sand passes a 2 mm (No. 10) sieve and is retained on a 425 μm (No. 40) sieve. Fine Sand will pass the 425 μm (No. 40) sieve and be retained on a 75 μm (No. 200) sieve. It will not form a ribbon.

Loamy Sand

100% of loamy sand material will pass a 2 mm (No. 10) sieve and will contain between 10 and 20% of the fine-grained silt and clay. This material is loose and granular when dry and the individual grains can be seen and felt. When moist, it will form a cast, but because it is non-plastic, it cannot be pressed into a ribbon. Loamy sand can be further classified as Loamy Coarse Sand, Loamy Fine Sand or Loamy Very Fine Sand.

Sandy Loam

This soil contains 20% to 50% silt and clay combined, but less than 20% clay. It must always contain 50% or more sand grains to be classified as sandy loam. Sandy loam is divided into two main groups, slightly plastic and plastic sandy loam.

Slightly Plastic Sandy Loam generally contains 10% or less clay. It will form a thin ribbon 0-19 mm (0-3/4") in length before breaking under its own weight.

Plastic Sandy Loam contains about 10% to 20% clay. It will feel gritty and can be pressed into a ribbon form 19 mm (0-3/4") to 25mm (1") in length.

Loam

Loam always contains more than 50% silt and clay combined. It is a relatively even mixture of sand and silt with less than 20% clay. It has a somewhat gritty feel but is smoother than a sandy loam. It will form a ribbon 5 mm (1/4 in.) to 37.5 mm (1½ in.) in length, but will be thinner and stronger than can be formed with sandy loam.

Silt Loam and Silt

Silt Loam contains more than 50% silt, 0 to 50% sand and less than 20% clay. (If the soil contains more than 80% silt and 0 to 20% sand, it is classified as silt.) When

pressed between the fingers, it will offer little resistance to pressure and feels smooth, slippery or “velvety”. Silt Loam is classified as slightly plastic when the ribbon length is between 0 and 19 mm (0 and 3/4”) and is classified as plastic Silt Loam when the ribbon length is between 19 mm (3/4”) and 37.5 mm (1 1/2”). Pure silt is non plastic and will not press into a continuous ribbon, but it will press into ribbons of up to 0 –10 mm (0-1/2”) in length, depending on the clay content.

Clay Loam (CL)

Clay Loam is fine textured and uniform in structure. It contains 20% to 30% clay, 20% to 50% silt and 20% to 50% sand. It is fine textured and forms a ribbon from 37.5 mm (1 ½ in.) to 62.5mm (2 ½ in.) in length before breaking. It requires considerable pressure to form a ribbon.

Silty Clay Loam (SiCL)

Silty Clay Loam contains 20% to 30% clay, 50% to 80% silt and 0 to 30% sand. This is a fine textured soil and forms a ribbon 37.5 mm (1 ½ in.) to 62.5 mm (2 ½ in.) in length without breaking. It does not offer as much resistance to pressure as clay loam and has a dull appearance, but is slippery.

Sandy Clay Loam (SCL)

Sandy Clay Loam contains mostly sand-sized particles but can contain 20% to 30% clay, 50% to 80% sand and 0 to 30% silt. It has a gritty feel compared to the more slippery feel of clay loam. It will form a ribbon 37.5 mm (1 ½ in.) to 62.5 mm (2 ½ in.) in length. It is seldom encountered in a natural state.

Clay (C)

Clay is fine textured and very plastic. Clay contains from 30% to 100% clay, 0 to 50% silt and 0 to 50% sand. It forms very hard lumps when dry. It is smooth and shiny and will form a long, thin, flexible ribbon 62.5 mm (2 ½ in.) or more in length.

Silty Clay (SiC)

Silty Clay contains mostly silt-sized particles. Silty Clay contains 30% to 50% clay 50% to 70% silt and 0 to 20% sand. It is very plastic but feels smooth and slippery and will form a ribbon 62.5 mm (2 ½ in.) or more in length. It has the feel and appearance of butter in its natural state.

Sandy Clay (SC)

Sandy Clay contains mostly sand-sized particles but can contain 30% to 50% clay, 50% to 70% sand and 0 to 20% silt. It is very plastic, but feels gritty. It will form a long, thin ribbon 62.5 mm (2 ½”) or more in length.

Organics (ORG)

Organic soils are generally considered to have greater than 2% organic content. Up to 25% the terms **slightly organic**, **organic**, and **highly organic**, precede the triangle classifications listed above. For example, a sandy loam with 8% organic material would be classified as **Organic Sandy Loam**.

Table 5-2: Classification of organic soils	
Classification	Organic Content by Weight (%)
non-organic	<2
slightly organic *	2 – 5
organic*	6 – 10
highly organic*	11 – 25
Peat (woody, fibrous, decomposed, etc.)	>25
<p>*Insert specific soil type, e.g. slightly organic Silt Loam, highly organic Loam, etc.</p> <p>Note: 1) The term non-organic should not be used in normal soil descriptions. (If no organic modifier is used, it is assumed that the soil is non-organic.) The term is included in the table for information only to complete the classification.</p> <p>Note: 2) The term mineral soil includes those soils with 5% or less organic materials.</p>	

Muck is an often-misused term.

1) The term muck is correctly used as in **Muck Excavation**, MnDOT 2105.2A3. This definition is as follows:

"Muck excavation shall consist of all saturated and unsaturated mixtures of soil and organic matter not suitable for foundation material regardless of moisture content, that is removed from below the natural ground level of marshes, swamps and bogs over which embankments are to be constructed and the excavation of which is required to provide a stable foundation for embankments or to accelerate the subsidence of unstable material under embankment load."

Because this use of the term is included in **MnDOT Standard Specifications for Construction**, this connotation is preferred over the more limited definition referenced in 2) below.

2) Historically, the term Muck has often mistakenly been used to identify organic material which is more highly decomposed and thus less fibrous than peat, and is thus not easily described by more definitive terminology or to describe organic deposits so completely disturbed by drilling that accurate classification is not possible. This use is not correct and should be discontinued.

Peat (more than 25 percent organic content), can be further subdivided as follows:

Partially decomposed peat is a short-fibered organic soil that may be fairly well decomposed and may contain mineral soil. Most of the fibers are less than approximately one eighth-inch (3 mm) in length.

Spongy peat is a well-decomposed organic soil that has been subjected to certain consolidation conditions that cause it to appear and feel spongy. It varies in its mineral soil content, and there is little or no fiber content visible.

Well-decomposed peat is an organic soil whose organic content has been subjected to a thorough decay process in which most fibers are invisible to the naked eye and which varies in its mineral content.

Semi-fibrous peat is an organic soil whose plant fibers range from approximately 3 to 25 mm (one-eighth to one inch) in length and are partially decomposed. These fibers may be mixed with some fairly well decomposed organic matter and have a varied mineral soil content.

Fibrous peat is an organic soil with plant fibers that are mostly 25 mm (one inch) or more in length and are partially decomposed. These fibers may be mixed with some fairly well decomposed organic matter and a small amount of mineral soil. The term "woody" is sometimes used for very coarse, minimally organic deposits.

Marls are carbonate-rich, light gray to almost white silts and clays formed by precipitation of calcite at the bottom of lakes or swamps. The carbonate generally precipitates directly out of the ground water but may also be deposited by carbonate-fixing organisms. An aggregate of carbonate shell material may also be called a marl. Due to their high carbonate content, marls will effervesce in dilute hydrochloric acid, differentiating them from the fine light gray sands also commonly found in swamp bottoms. Marls are unsuitable for road construction due to difficulty in compaction and instability in the presence of water.

In general, gravel and coarser sands are excellent for upper embankment materials; finer sands, loamy sand, sandy loam, and loam are excellent to good; clay loam and sandy clay loam are good to fair; silt loam and silty clay loam are fair to poor; and sandy clay, clay, and silty clay are poor.

The map below shows a generalized soils map of the state. Those areas are highlighted where granular soils, clay soils, loamy soil, or organic soils are likely to be found at the surface.

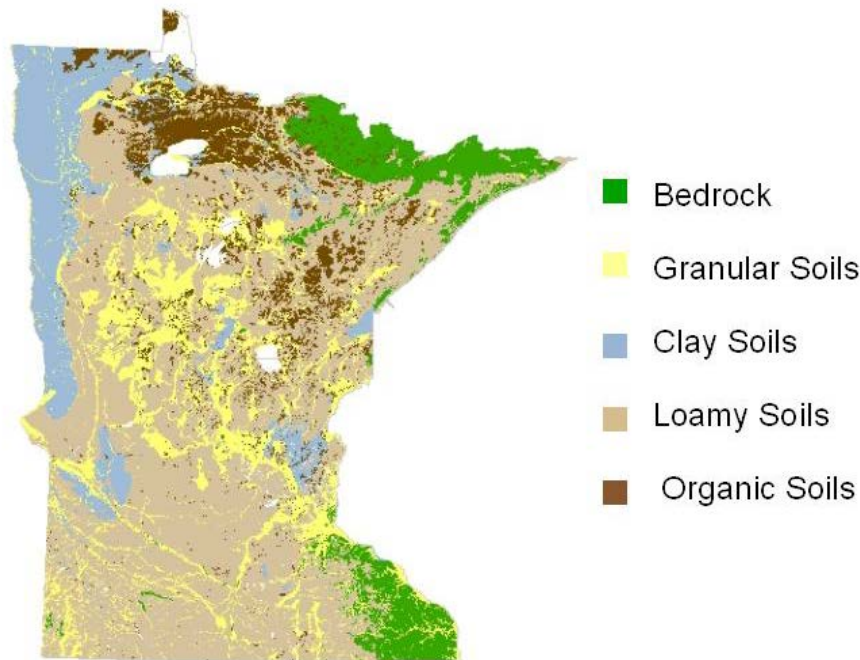
Figure 5-3: Generalized Soils Map

5.2.2 AASHTO

In 1928, the Bureau of Public Roads introduced a classification system with eight soil groups, designated A-1 through A-8, to be used for assessing the suitability of road subgrade. Major revisions to the system, have resulted in the currently used classification system. This system is based on the grain-size distribution (sieve Nos. 10, 40, and 200, only) and plasticity, and allows for a quick rational method of categorizing either undisturbed natural soil or fill and associating their properties relative to performance as a subgrade material. The system has been found to be applicable in areas with vastly different soil types and origins. In addition to the seven classifications shown, Group A-8 has been added to include highly organic soils (peat or muck).

5.2.3 Unified Soil Classification System

Another classification system widely used throughout the engineering community is the Unified Soil Classification System (USCS). The present system, modified by the U.S. Army Corps of Engineers and the Bureau of Reclamation, was introduced during World War II by Casagrande of Harvard University to assist engineers in the design and construction of airfields. As with the AASHTO system, the USCS utilizes grain-size distribution and plasticity characteristics to classify soils. The USCS, however, categorizes soils into one of 15 major soil groups, additionally accounting for the shape of the grain-size distribution curve.

In the USCS soils are represented by a two letter symbol. The first letter represents soil type that comprises over 50% of the sample while the second letter defines sample properties.

Table 5-3: USCS Definitions

Soil Type			
G	Gravel	P	Poorly graded
S	Sand	W	Well graded
M	Silt	H	High plasticity
C	Clay	L	Low plasticity
O	Organic		

5.3 Rock Classification

The MnDOT Geology Unit obtains rock samples for several purposes but primarily for aggregate quality assessments and geotechnical investigations. They are obtained by hand sampling or from core drilling performed by the Foundations Unit drill crews or by consultant drill crews. Rock coring and hand sampling are undertaken to obtain samples of in-place rock in proposed construction areas or at aggregate/mineral sources. Samples are identified, characterized, and their descriptions are placed on a graphic log (typically a boring log or stratigraphic column) depicting their relative position to other collected samples. Samples are often tested to determine their engineering or aggregate quality characteristics. The data obtained is subsequently utilized for making recommendations pertinent to the design of various structures (such as bridge foundations, tunnels, rock cuts and retaining walls and roadways), pavement mixes or bases. Proper characterization of rock is key to making sound design and aggregate quality recommendations. This guide has, thus, been assembled to assist not only with accurate characterization of rock but also to ensure consistency and uniformity in rock sample description and boring log construction within the Geology Unit as well as for work completed for MnDOT by consulting firms.

5.3.1 Lithology

Rocks are divided into three main categories based on their genesis. **Igneous** rocks are formed by the cooling of liquid magma, **sedimentary** rocks by the breakdown through weathering of an existing rock mass or via chemical precipitation, and **metamorphic** rocks by transformation of preexisting minerals in response to varying degrees of temperature and/or pressure.

Igneous

Igneous rocks are classified based on their mineral composition and grain-size, which is a result of the cooling rate of the parent magma. **Extrusive** rocks cooled quickly when molten material was brought to the surface during volcanic activity, resulting in a fine-grained (aphanitic) texture, often too fine to see without magnification. **Intrusive** rocks cooled and crystallized from magma remaining deep within the earth, producing larger grains (phaneritic), typically easily seen with the unaided eye.

The greatest exposure of igneous rocks in Minnesota is along the north shore of Lake Superior, where basalt, andesite and, rhyolite lava flows, as well as several large intrusive bodies of gabbro, are exposed. Granite and metamorphic rocks (gneiss, schist, migmatite, etc.) outcrop in the St. Cloud area, near the Canadian border, and along the Minnesota River Valley between Ortonville and New Ulm.

Mafic

Magmas that are rich in iron, magnesium, and calcium are referred to as mafic and produce greater quantities of dark colored minerals, such as olivine, pyroxene, and calcic plagioclase, resulting in 'dark' colored rocks. Colors considered dark are dark gray and black. The two most common mafic rocks are **basalt**, a fine-grained/aphanitic rock, and **gabbro**, a coarse-grained/phaneritic rock.

A common form of basalt found on Minnesota's North Shore is referred to as **amygdaloidal**. Amygdaloidal basalts are identified by the presence of scattered pea-sized spheroids that are composed of zeolites, calcite, epidote, chlorite or combinations of these minerals. These secondary minerals formed in preexisting air void spaces (vesicles) that were created by gas bubbles trapped near the surface as an extruded lava flow cooled. Zones of amygdules typically mark the tops of individual lava flows, and are often a zone concentrated weathering, reducing the strength of the rock to a near-soil condition. An interesting feature associated with amygdaloidal flow tops is that they can occur at multiple depths, with each successive lava flow. Thus, care must be taken to explore below designed footing elevations to make sure no weak amygdaloidal zones are lurking beneath.

Many of the basalts and gabbros in Minnesota display a texture referred to as **ophitic**. This texture describes a mineralogical framework where plagioclase minerals are encapsulated within pyroxene minerals. Gabbros that possess this texture are referred to as **diabase**, whereas **ophitic basalt** is used for the aphanitic equivalents. These rocks, when weathered, often have a "spotted" appearance.

Some igneous rocks have minerals that are both coarse and fine-grained. Igneous rocks displaying bimodal grain-sizes are termed **porphyritic**. The porphyritic basalts on the North Shore are composed of coarse-grained laths of plagioclase (some several inches long), which 'swim' in a matrix of fine-grained mafic minerals. Porphyritic rocks formed from an early stage of slow cooling followed by a later stage of rapid cooling.

As a general rule, the coarse-grained (intrusive) igneous rock bodies have more pronounced and through-going joint systems, whereas the fine-grained rock bodies (typically lava flows) have very closely-spaced, discontinuous joint systems. Outcrops along the North Shore are easy to differentiate because the intrusive rock bodies form prominent noses at the intersections of primary joint structures. The extrusive rock bodies are often highly fractured with little or no visible structure. These differences become important when designing backslopes in these materials. As a result of weathering, much of the basalt on the North Shore has been altered to a reddish color from oxidation of iron-bearing minerals and should not be mistaken for **felsic** igneous varieties.

Felsic

Magmas that are rich in silica and aluminum are referred to as felsic. They tend to produce more quartz, potassium feldspar, and sodic plagioclase; which generally form 'light' colored rocks. Colors considered light are white, light gray, pink, and red. An abundance of SiO₂ (quartz) in the rock dictates the felsic composition. The most common felsic rocks are **rhyolite** (fine-grained) and **granite** (coarse-grained).

Intermediate

Intermediate rocks, as the name suggests, are intermediate between mafic and felsic rocks. They often contain both dark and light minerals. A coarse-grained intermediate rock, such as **diorite**, will have a 'salt and pepper' appearance due to the mixture of light and dark minerals. **Andesite**, a fine-grained intermediate rock, is typically green, dark gray, or red, but is difficult to distinguish from either basalt or rhyolite because its color can be similar to either.

Sedimentary

Sedimentary rocks are classified on the basis of their depositional mode, grain-size, mineralogy, mode and extent of lithification and relationship between grains. Sedimentary rocks are separated into two major categories, **clastic** or **chemical**, depending on their depositional mode.

Clastic

Clastic sedimentary rocks are composed of eroded fragments of preexisting rocks, and are classified by their particle size, ranging from gravel to clay.

Conglomerate and Breccia

These are sedimentary rocks in which gravel sized or larger material is found in a matrix of fine-grained material. The term conglomerate is usually applied to rocks in which the coarse fragments are subangular or more completely rounded, whereas the term breccia is used if the grains are angular.

The individual fragments that make up a conglomerate or breccia may be of any lithology. For example, in the Sioux Quartzite Formation, a basal conglomerate is present outcropping near New Ulm and is composed of clasts of vein quartz, jasper, chert and cherty iron formation all present within a sandy matrix.

Breccias are often found in brittle fault zones where the grinding action between adjacent bodies of rock creates angular fragments. They are also created where pyroclastic flows were present such as in the Ely Greenstone. Breccias have been identified in cores taken from dolostone of the Prairie du Chien Group where they are found in crevasses or cracks that were later filled with sand and angular clasts of dolostone.

Sandstone

Sandstones are composed predominantly of sand-sized quartz grains. In Minnesota, most of these sandstone grains are held together by calcite or quartz cement, which was deposited around the grains by intermoving pore fluids during burial. In some

cases the cement is composed of hematite and, more rarely (such as in the interflow sandstones on the North Shore), by epidote, prehnite or zeolites (laumontite).

Grain-size, hardness and mineral constituents typically describe sandstones. Well-sorted sandstone that contains more than 95% quartz grains is given the name quartzose sandstone or arenite. Other special terminologies for sandstones include arkose (rich in feldspar), and wacke (sand-sized fragments, not having grain to grain contact but supported by a matrix of clay or silt-sized material).

Glauconitic is a commonly used term for green-colored sandstones whose main mineral constituent, after quartz, is glauconite. Glauconitic sandstones are typical of the Franconia Formation and can be found in other Paleozoic formations (including carbonates) throughout southeastern Minnesota.

Shale and Siltstone

This group of sedimentary rocks includes all those rocks in which the grains are smaller than sand size (silt and clay sized). **Shale** is a fine-grained rock composed of 2/3 or greater percentage of clay particles, and is characterized by a finely laminated structure, which imparts a fissility (ability to split along a plane of weakness) parallel to the bedding. **Siltstone** is the term applied to fine-grained rocks that are composed of 2/3 or greater percentage of silt, and that lack the fissility of shale. In practical terms, silt and clay sizes are too small to be visible to the unaided eye, but silts can be detected by their gritty nature between the teeth. In contrast, clay sizes behave as a paste between the teeth. Neither siltstone nor shale is very strong rock and they tend to weather rapidly upon exposure to the elements. They also are often sources of slope instability because of their low permeability, causing water to be trapped on top of them, and because of their lack of strength

The term shale, technically, should be applied only to those rocks that show bedding-plane fissility or laminations. The less frequently used term of **mudstone** can also be applied to silt and clay-sized bearing material which displays no fissility. In the Shakopee Formation, for example, mudstone is typically found interspersed throughout as one to two inch thick beds and is easily identified by its light green color and plasticity.

Siltstones are often white or light gray. The most common occurrence is the Blue Earth Siltstone bed, part of the Oneota Formation, found extensively along the Minnesota River Valley near St. Peter. Siltstone also occurs in Cretaceous rock found in the southern and western portion of the state.

Chemical

Chemical sedimentary rocks are those that are composed primarily of material formed directly by precipitation from solution or colloidal suspension. Precipitates are commonly carbonates, quartz or iron.

Carbonates

Limestone and **dolostone** are loosely referred to as carbonates because of the carbonate anion found in the prevailing minerals within these rocks. Calcium carbonate, calcite, is the main ingredient of limestone. Calcite is precipitated out of water by chemical or biologic means (as aragonite), or it collects as a mass of shell material. Subsequent lithification produces crystalline limestone. Chemical substitution of magnesium carbonate, dolomite, for calcite during burial yields dolostone or dolomitic limestone. This process usually obscures primary structures, such as bedding or fossils and occasionally creates a sucrosic, sugary, texture from volume reduction. The calcite in limestone will effervesce freely in dilute hydrochloric acid. Dolostone, however, will react with acid after powdering, yielding a good tool for differentiating limestones from dolomitic limestones and dolostones.

Carbonates situated near the water table, either in present day or in ancient times, may have undergone dissolution by slightly acidic ground water, creating enlarged joints, cavities, or caves. There may be more than one horizon of caving or dissolution due to changes in ground water level through time. Small surface depressions, known as sinkholes, are the result of loss of soil into these solution cavities, or the roof collapse of near-surface caves. The topography produced by the progressive dissolution and collapse is known as **karst**. Areas of karst topography or known caves may possess marginal foundation conditions due to past collapses and continued dissolution of the bedrock. The majority of Minnesota's karst topography is located in the southeastern counties of Fillmore, Winona, and Olmsted.

Chert

Chert is composed of cryptocrystalline quartz crystals with interspersed submicroscopic pores, and like quartz, has a conchoidal to splintery fracture. Chert is hard, typically light gray, and weathers to a soft, dull white, chalky substance which is often present around an unweathered chert core.

Chert can be found in limestones, dolostones or shales either as nodules or forming thin beds. Tiny oolites are often visible within the nodules or beds. Chert is also a component of iron formation rocks found in the various iron ranges. Appreciable quantities of chert may cause difficulty in drilling shafts or piers. As an aggregate, chert can create freeze-thaw and chemical durability issues.

Metamorphic

Metamorphic rocks are derived from preexisting rocks that have been exposed to varying degrees of heat and pressure resulting in mineral assemblages that are stable in the imposed metamorphic environment. Classification is based on composition and texture. Frequently, metamorphic rocks are not referred to by their metamorphic rock equivalent terms, but are instead described as being metasedimentary, metabasaltic, metavolcanic, etc. This general use of the prefix 'meta' is commonly, although not always, used when the original rock has undergone lower grades of metamorphism, with the parent rock being easily identified. Occasionally, primary structure, such as original bedding or ripple marks, may be preserved, albeit in a distorted form.

Metamorphic rocks are divided into two groups based on the presence or absence of **foliation**.

Foliated Rocks

Foliation is a planar element in metamorphic rocks. Foliation is the result of the reorientation of minerals in response to heat and pressure. It may be expressed as closely spaced fractures (slatey cleavage), parallel arrangement of platelike minerals (schistosity) or by alternating layers of differing mineralogic composition (gneissic layering). Common foliated rocks, in order of decreasing degree of metamorphism, are **gneiss, schist, and slate**.

Gneiss

Gneiss is a coarse- to medium-grained banded rock composed predominantly of quartz, feldspar, mica, and amphiboles. Though mineralogically similar to granite, it is distinguished from igneous rocks by dark and light colored bands that result when minerals segregate during metamorphism. Commonly quarried as building stone, gneisses are common in the Minnesota River Valley, and are currently mined as aggregate in the Morton area.

Schist

Schist is a coarse- to medium-grained rock, in which the foliation is due to parallel arrangement of platelike minerals, such as mica, chlorite, and talc. It is usually classified on the basis of the constituent minerals present, which indicate the degree or intensity of metamorphism to which the rock has been subjected, e.g., chlorite, biotite-muscovite, garnet, kyanite, or staurolite schist.

Slate

Slate is an extremely fine-grained rock derived principally from shale. The particles have a very strong alignment, which results in a well-developed platelike cleavage. This cleavage causes the slate to split easily along closely spaced parallel planes. The presence of adversely oriented cleavage may make excavation of cuts difficult and result in potentially unstable slopes.

Other

Other metamorphic rocks not described above include phyllite and argillite. **Phyllite** is a fine-grained rock, intermediate in grade between slate and schist. Minute crystals of mica or chlorite impart a silky sheen to its cleavage surfaces. **Argillite** is commonly used to describe a rock derived from shale, which is intermediate between shale and slate, but lacks both the fissility of shale and the cleavage of slate.

Non-foliated (Massive) Rocks

Non-foliated or massive metamorphic rocks do not vividly possess the planar structures resulting from the flattening or segregation of the constituent grains. In some cases, the metamorphic conditions imposed upon the parent rock type may have been too low to impart a noticeable foliation. Additionally, some rocks are composed of only one mineral type making it difficult to detect foliation. Common non-foliated rocks are **quartzite and marble**.

Quartzite

Quartzite results from the deformation of sandstone. Quartzites are principally composed of quartz but often contain some minor accessory minerals, such as hematite. At low metamorphic grades, quartzite results from the fusing of sand grains via pressure solution along grain boundaries. At higher grades, quartzite forms from recrystallization of the grains resulting in a strong interlocking mineral fabric. Though typically considered a nonfoliated metamorphic rock type, quartzites that have undergone moderate to high-grade deformation may display some foliation. In either case, the rock is very hard and breaks across or through the grains rather than around them, as in a sandstone. The most common occurrence in Minnesota is the Sioux Quartzite, a low-grade form, quarried near New Ulm, Courtland and Jeffers.

Marble

Marble is the result of heat and pressure imposed on limestone or dolostone. Though foliation can be found in some marbles, most marbles lack a preferred grain orientation since carbonate minerals easily recrystallize under most metamorphic conditions forming a coarse-grained interlocking texture. Marble is characterized by its softness and its effervescence with dilute hydrochloric acid. Marble is not commonly found in Minnesota, but thin beds of it have been encountered in the Thomson formation and Archean Greenstones.

5.3.2 Rock Sample Description Standards

This section covers standard definitions that will be used on MnDOT boring logs and by consultants performing work for MnDOT. Many of the geological terms, such as hardness, degree of weathering, etc., are subjective and often vary according to the user. Using the terminology as defined herein will ensure uniformity of rock descriptions.

Unlike other engineering materials, rock presents the designer with unique problems. Rock is a complex material varying widely in its properties, and in most engineering situations, not just one, but a number of rock types will be present. The geotechnical engineer and geologist are confronted with rock as an assemblage of blocks of rock material separated by various types of discontinuities, such as joints, faults, bedding planes, and so on. They must therefore consider the characteristics of both the intact rock and the discontinuities, which leads to a classification consisting of two basic assessments, sample characteristics and rock mass characteristics:

Sample Characteristics

Consists of a written **classification** of the intact rock core, or hand sample in regards to lithology, degree of weathering, grain-size, voids, hardness, and color. Rock descriptions should also include stratigraphic classification when known.

Rock Mass Characteristics

Consists of a quantitative classification of the in place rock mass. It encompasses primarily structural or lithological **discontinuities**, such as bedding, joints, faults, and formational contacts as well as the amount of core recovery. Characteristics of the rock

mass are obtained by measurements of **Recovery (REC)**, **Average Core Length (ACL)**, **Rock Quality Designation (RQD)** and **Fractures per Interval (Core Breaks)**.

The information obtained from these assessments is transferred from the boring log to a database, 'gINT', which produces a hard copy of the log displaying the 'Sample' and 'Rock Mass' characteristics as well as header information, depths/elevations of sampling, drilling operations, formation/member designation, and data obtained from testing.

Sample Characteristics: Structure of Classification

In order to maintain consistency in the rock description portion of the boring logs, grammatical and structural standards have been proposed for the various aspects of the classifying process. The following is an accepted order and list of *sample characteristics* as viewed in the field or in the lab to be used while classifying rock:

1. Rock Type/ Weathering
2. Texture
3. Bedding/joint frequency
4. Voids
5. Hardness
6. Color

Figure 5-4 Sample gINT log

MINNESOTA DEPARTMENT OF TRANSPORTATION - GEOTECHNICAL SECTION
 LABORATORY LOG & TEST RESULTS - SUBSURFACE EXPLORATION



UNIQUE NUMBER 74020

U.S. Customary Units

State Project		Bridge No. or Job Desc.		Trunk Highway/Location		Boring No.		Ground Elevation		
8580-149				Interstate Highway I-90		T124		700.2 (Surveyed)		
Location Winona Co. Coordinate: X=581305 Y=104693 (ft.)				Drill Machine 205120 CME/C55 Track		SHEET 1 of 1				
Latitude (North)=43°51'34.84" Longitude (West)=91°18'30.34"				Hammer CME Automatic Calibrated		9/1/10				
No Station-Offset Information Available										
DEPTH	Depth	Lithology	Classification	Drilling Operation	REC	SPT	MC	COH	γ	Other Tests
	Elev.				(%)	N ₆₀	(%)	(psf)		
										Formation or Member
	0.5		Sand and Gravel, gray and very moist		67	20	9			
	699.7		Loamy Sand with a little Gravel and a few stone pieces, brown and moist			6	8			
	2.0				83	20	12			
	698.2		Loamy Sand, brown and light brown, wet			50/4	3			
	3.0		Top of Bedrock @ 3'		135	50/3	8			WONEWOC SANDSTONE
	697.2		SANDSTONE, medium to coarse grained, clean sand, IOS orange to tan.		167	50/3	3			
	9.0				83	50/4	6			
	691.2		SANDSTONE, fine to medium grained, clean sand, some IOS, pale yellow.							
	11.0									
	689.2		SANDSTONE, fine to medium grained, thin bedding, clean sand, some IOS, alternating zones of very soft to moderately hard, tan to yellow-orange IOS.		84	N/A	N/A			
	15.0									
	19.0									
	681.2		SANDSTONE, coarse grained, thin bedding, clean sand, IOS, soft to moderately hard, tan to IOS orange.		99	N/A	N/A			
	21.0									
	679.2				100	N/A	N/A			
	25.0									
	30.0				48	N/A	N/A	N/A		
	35.0		SANDSTONE, fine to medium grained, thin bedded, IOS with a dark brown zone from 41.3' to 42.5', hardness is very soft to soft with some moderately hard zones, tan to orange-brown.		85	N/A	N/A			
	40.0				73	N/A	N/A			
	45.0				97	N/A	N/A			
	44.3									
	655.9		SANDSTONE, fine to medium grained, thin bedded, dark brown form 44.3' to 49', soft becoming moderately hard with depth, tan to brown.		93	34	0.43	6	15	
	50.0									
	51.0									
	649.2		Bottom of Hole - 51.0' No water encountered or measured during drilling							

Sample Characteristics
↓

Rock Mass Characteristics
↓

(*ROCK TYPE is typically first unless the rock is weathered, see Weathering Nomenclature)

An example rock description for a portion of rock core displayed in 'gINT' format is shown below:

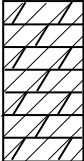
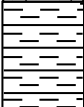
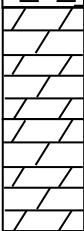
	WEATHERED DOLOSTONE; very thin to thin bedded; scattered very thin beds of argillaceous dolostone; light green shale and weathered chert; brecciated @ 3.9 ft.; moderately hard; dark yellow-orange to very pale orange.
	SHALE, slightly weathered; blocky to dense; slightly dolomitic; soft to moderately hard; green-grey to medium light gray.
	ARGILLACEOUS DOLOSTONE, fresh; highly fractured w/sealed cracks; moderately hard; pale orange.

As seen in the example description, a semicolon separates rock characteristics. Occasionally, several **descriptors** are needed to describe a particular rock characteristic. In such cases, a **comma** is used to separate them. For example:

	DOLOSTONE , slightly weathered; very thin to thin bedded; vuggy, fractured w/sealed cracks, chert from 2.3 ft. to 2.5 ft. and scattered argillaceous dolostone nodules; mod hard to hard; pale yellow brown.
---	---

Rock Type and Weathering Characteristics

The usage of rock type nomenclature should be based on current classification systems commonly used by the geologic community. Nomenclature put forth in this document contains elements from several different schemes plus it has been modified to some extent to fit MnDOT's needs.

Rock Type

Rock type is the first descriptor used in a rock core description:

The rock type is **always** capitalized and precedes the **degree of weathering** (written in lower case) with a comma except in cases where the degree of weathering is more than 'slightly weathered' (see 'Weathering Nomenclature For Rocks', Table 3-15). For those

cases, the weathering descriptor precedes the rock type and is also capitalized. For example:

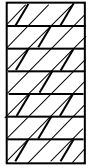

WEATHERED DOLOSTONE; very thin to thin bedded; scattered very thin beds of argillaceous dolostone; light green shale and weathered chert; brecciated @ 3.9 ft.; moderately hard; dark yellow-orange to very

Rock type modifiers, such as 'argillaceous' or 'sandy' are also allowed particularly when several variations of a particular rock type are found in the same boring.

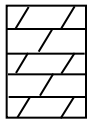

SANDY DOLOSTONE, slightly weathered; very thin bedded; moderately hard to hard; pale yellow-brown to dark orange.

or,

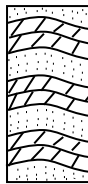

ARGILLACEOUS DOLOSTONE, slightly weathered; thin bedded; fractured w/sealed cracks; some weathered, light green shale in middle of unit; moderately hard; Very pale orange.

Weathering

Weathering and chemical alteration are important aspects of rock classification that can affect both intact rock and rock mass properties. In the earliest stages, weathering is manifested by discoloration of intact rock and only slight changes in rock texture. With time, significant changes in rock hardness, strength, compressibility and permeability occur and the rock mass is altered until the rock is reduced to soil. Alteration may also occur at depths far below surface. The table on the following page shows the weathering nomenclature used by the MNDOT Geology Unit:

Table 5-4: Weathering Nomenclature for Rocks		
	Degree of Weathering	Description
Bedrock	ROCK TYPE, Fresh	Rock fresh, crystals bright, few joints may show slight staining. Rock rings under hammer if crystalline.
	ROCK TYPE, Generally fresh with slight weathering	Rocks generally fresh, joints stained, some joints may show thin clay coatings. Crystals in broken face shine brightly. Engineering characteristics essentially the same or very slightly reduced from those of fresh rock.
	ROCK TYPE, Slightly weathered	Rock slightly weathered, joints stained with discoloration extending into rock up to one inch. Joints may contain clay coatings. Engineering characteristics slightly reduced from those of fresh rock.
	WEATHERED, ROCK TYPE	Rock moderately weathered, significant portions of rock show discoloration and weathering affects. Crystals are dull and show visible chemical alteration. Rock has dull sound under hammer and shows a significant loss of strength compared to fresh rock.
	HIGHLY WEATHERED ROCK TYPE	Rock is highly weathered; all rock except quartz is discolored. In granitoid rocks, all feldspars are dull, discolored, and the majority show kaolinization. Rock shows severe loss of strength and can be excavated with a geologist's pick. Rock goes 'clunk' when struck.
Residual Soil	SEVERELY WEATHERED ROCK TYPE (Residual Soil)	Rock is severely weathered; all rock except quartz is discolored or stained. Rock fabric is clear and evident, but reduced in strength to a strong soil. Some fragments of strong rock usually remaining.
	VERY SEVERELY WEATHERED ROCK TYPE (Residual Soil)	Rock is very severely weathered, all rock except quartz is discolored or stained. Rock fabric is discernible, but the mass is effectively reduced to soil with only fragments of strong rock remaining.
	RESIDUAL SOIL, parent rock is ROCK TYPE	Rock is reduced to soil. Rock fabric not discernible or is discernible only in small-scattered location. Quartz may be present as dikes or stringers.

Severely Weathered Rocks (Residual Soil)

As was discussed in the Rock Type section and is visible in the table above, the weathering term follows the capitalized lithology term when the bedrock is **fresh** to **slightly weathered**. For rock types that are **WEATHERED** to **HIGHLY WEATHERED**, the weathering description comes before the rock term, and is also capitalized. Rock samples displaying more weathering than **HIGHLY WEATHERED** characteristics are no longer considered rock but are termed **residual soil** and should be noted after the rock type in the description. Also, a 'Residual Soil' **materials symbol** in 'gINT' is used for samples classified as residual soil. For example:

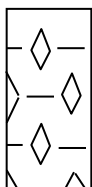

SEVERELY WEATHERED GRANITE (Residual Soil); friable; rock fabric is discernible, but the mass is effectively reduced to soil with only fragments of strong rock remaining; dark green-grey w/some pink.

Top of Bedrock

The placement of '**Top of Bedrock**' in the classification portion of the driller's log and gINT log is dependent on the degree of weathering. Rocks displaying weathering characteristics typical of 'Residual Soil' are NOT considered bedrock.

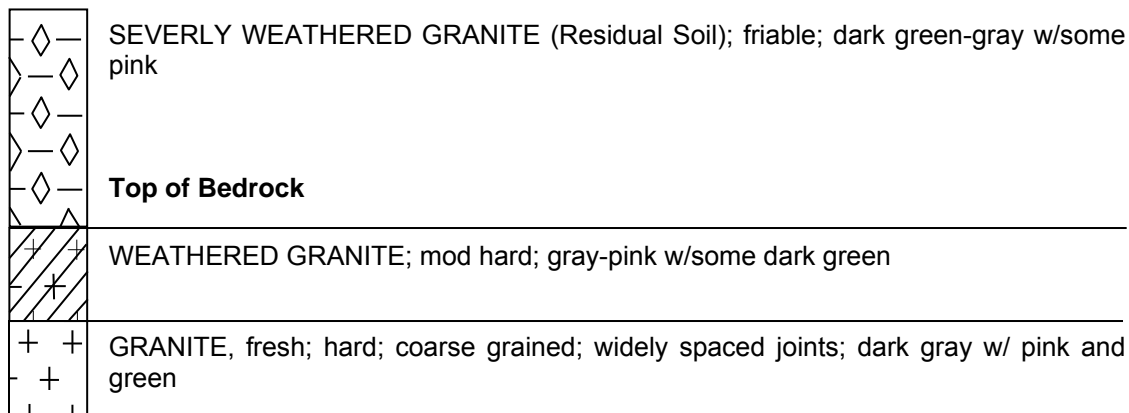

Additionally, a 'Top of Bedrock' **line** is drawn in the 'Remarks' column of the gINT log at the same depth as where the top of bedrock was determined in the 'Classification' column. The formation name of the rock should be placed directly below this line and printed in **capital letters**. If the member name is known, it should be positioned below the formation name and only the first letter of each word should be capitalized (see example of boring log in Core Breaks discussion).

In most cases, the top of bedrock in the field will not correlate to the depth where rock coring was initiated. In the field, the top of bedrock is typically encountered either during split tube sampling, augering or plug drilling. Therefore, the field crew chiefs have been instructed to write in the boring log the depth at which bedrock was encountered during drilling. If this information is not given, sound judgment should be used in determining the depth to top of bedrock. In such instances, statements such as 'Possible Top of Bedrock' or 'Probable Top of Bedrock' can be used instead of 'Top of Bedrock' in the Classification portion of the logs.

Degree of Weathering in Sandstone/Degree of Cementation

Establishing degree of weathering in core-recovered sandstone can be difficult, if not impossible, considering that most of the sandstones encountered during drilling are cemented by carbonates and are for the most part, free of fine-grained material such as silts and clays. In these sandstones, the only recognizable evidence of alteration, in most cases, is visible in the cement fraction of the rock. Consequently, the classifier often has to judge whether potentially 'weathered' sandstone was originally weakly cemented versus the cement being subjected to dissolution/chemical weathering at a later time. To avoid misrepresentation, the weathering criteria mentioned above **is not** applied to carbonate-cemented sandstones obtained from **core drilling**. Since the

degree of weathering is often a means of inferring rock strength, the classifier should instead accurately assess the rock hardness, discussed later, or perform unconfined compressive strength testing.

HOWEVER, if the Standard Penetration Test has been performed in sandstone during drilling or prior to or during coring or both, a degree of weathering IS assigned to the sandstone and noted in the classification. An empirical 'weathering' criterion was established years ago for St. Peter Sandstone by MNDOT based on the number of **blow counts** recorded during the Standard Penetration Test. To maintain consistency, the correlations between SPT and 'degree of weathering' are to be used in clean (generally free of miscellaneous constituents such as silts and clays), friable, carbonate-cemented sandstones such as those found in the St. Peter, Jordan and portions of the Franconia Formation. The relationship between SPT and weathering is displayed below:

Table 5-5: Weathering Criteria for Sandstone		
Term (bpf)	Description	Typical SPT
Sandstone Sand	Sand of generally uniform rounded size and color composed predominately of rounded quartz grains; may contain up to 50% foreign glacial type sand or fine gravel.	30-50/0.7'±
Sandstone, weathered	Typical sandstone without foreign material. If present, such material is designated as the "Top of Bedrock." (Note: Three tenths of a food penetration is borderline or transitional into fresh sandstone.)	50/0.7' - 50/0.3'±
Sandstone, fresh	Dense, typical quartzose sandstone. Frequently, no samples are recovered.	50/0.3' - 50/0'

Texture

Texture pertains to the size, shape, surface characteristics, and arrangement of individual grains or crystals in a rock. In most cases, a grain-size description is all that is necessary to describe texture. **Contrary to geologic convention, grain-size nomenclature will be uniform for the igneous, sedimentary and metamorphic classifications.** The tables below outline the accepted grain-size terminology for each of the three major rock groups:

Table 5-6: Grain-size Terms for Igneous and Metamorphic Rocks	
Term	Size of Grains
Fine-Grained	Individual crystals are not visible to the unaided eye.
Coarse-Grained	Individual crystals are readily visible .

Table 5-7: Grain-size Terms for Sedimentary Rocks		
Sieve	Term	Size of Grains
#200	Cryptocrystalline	Grains not visible with microscope
	Microcrystalline	Grains only visible with aid of microscope
	Clay-Sized	<0.00015 in
	Silt-Sized	0.00015 in to 0.002 in
-#4	Very Fine-Grained	0.002 in to 0.005 in
	Fine-Grained	0.005 in to 0.01 in
	Medium-Grained	0.01 in to 0.02 in
	Coarse-Grained	0.02 in to 0.04 in
	Very Coarse-Grained	0.04 in to 0.08 in
	Granule-Sized	0.08 in to 0.16 in
+#4	Pebble-Sized	0.16 in to 2.5 in
	Cobble Sized	2.5 in to 10.0 in
	Boulder-Sized	>10 in

Grain-size terms should be written out completely, as opposed to abbreviated, to avoid confusion between the many terms available. However, for the commonly used grain-sizes *shorthand versions* are allowed if space requires, as shown as follows:

Very Fine-grained	<i>VF grained</i>
Fine-grained	<i>F grained</i>
Medium Grained	<i>M grained</i>
Coarse-grained	<i>C grained</i>
Very Coarse-grained	<i>VC grained</i>

Crystallinity is a textural property sometimes identified in chemical sedimentary rocks. Some limestones and dolostones display textures that are similar to coarse-grained/phaneritic igneous rocks and can be described as **crystalline** or **slightly crystalline** in the rock description.

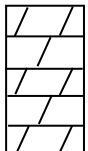

DOLOSTONE; slightly weathered; thin bedded; vuggy; **crystalline**; scattered laminae of light green shale and infilled brecciated zones; moderately hard to hard; light gray to gray orange

In contrast, **lithographic** is a term typically used to describe carbonate rocks that are exceedingly fine-grained, have a creamy appearance and conchoidal fracture. Lithographic limestone or dolostone is also classified as **micrite**, according to Folk's 1962 carbonate rock classification. Some units, such as the Devonian-aged Cedar

Valley Formation, contain thick beds of lithographic to sublithographic limestone whereas, lithographic beds in the Prairie du Chien Group are typically not thicker than a foot. Identification of these lithographic dolostones is aided by the presence of pyrolusite which forms dendritic patterns along fracture planes and are often associated with overlying or underlying mudstone seams/beds (the lithographic dolostone is often argillaceous, containing roughly 10 to 15% by mass of -#200 material).

Discontinuities

Geologic discontinuities are **breaks** or visible **planes of weakness** in the rock mass that separate the rock mass into discrete units. They include structural features, such as joints and faults, and depositional features, such as bedding planes. Properties of geologic discontinuities that are measured in core samples include **attitude** and **spacing**. The frequency with which discontinuities occur is implied by the Fractures per Interval measurement and is described in the Rock Mass Characteristics section.

Joints

A **joint** is a fracture or parting in a rock, along which there has been no visible movement parallel to the joint surface. Movement may occur at right angles to the joint surface causing the joints to separate or open up. Joint surfaces are usually planar, and often occur with parallel joints to form a joint set. Two or more joint sets that intersect define a joint system. Joints may range from perpendicular to parallel in orientation with respect to bedding.

Bedding Planes

A **bedding plane** is a planar or nearly planar surface that visibly separates each successive layer of stratified rock (of the same or different lithology) from the preceding or following layer. It may or may not be physically separated (appear as a fracture).

Faults

A **fault** is a major fracture along which there has been appreciable displacement. The presence of gouge (pulverized rock), bedding offset, and/or slickensided surfaces (commonly with mineral or clay coating) may be indicators of fault movement. In practice, a precise distinction between joints and faults may not be possible or significant.

Attitude refers to the inclination of a discontinuity measured from horizontal. The inclination may be expressed in degrees but preferably by using the descriptive terms given below:

Term	Angle (degrees)
Horizontal	0-5
Shallow or low angle	5-35
Moderately Dipping	35-55
Steep or High Angle	55-85
Vertical or near Vertical	80-90

Spacing refers to the distance between fractures or thickness of beds visible in the core. In the case of fractures, spacing **does not** represent the thickness of the open space produced by a fracture, but rather the amount of rock material between two distinct fractures. For bed thickness, the term represents the amount of rock material between two distinct bedding planes. Discontinuities, such as joints and fractures, are often found in crystalline rock that has undergone deformation. Whereas bedding terms are typically used for sedimentary rocks such as sandstones and carbonates. A description of the joint or bedding face is often helpful since secondary mineralization is often found coating fracture faces or sealing the fracture space completely. Joint and bedding terms used to describe spacing are given in the following table:

Joint Term	Bedding Term	Spacing (in)
Very Close	Laminated	<0.5
Close	Very Thin	0.5-2
Moderately Close	Thin	2-12
Wide	Medium	12-36
Very Wide	Thick	>36

An example of a joint description would be:

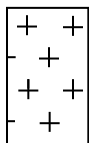

QUARTZ MONZONITE, generally fresh w/slight weathering; **scattered high and low angle, closely spaced fractures**; biolitic; very hard; light gray

Or, as in the case of sedimentary units:

Voids

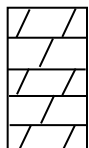

DOLOSTONE, slightly weathered; **very thin to thin bedded**; vuggy; fractured w/sealed cracks; chert from 2.3ft to 2.5ft and scattered argillaceous dolostone nodules; moderately hard to hard; pale yellow brown

Voids are open spaces in the subsurface rock that generally result from the removal of rock materials by chemical dissolution or the action of running water. Removal can occur along bed or joint faces to form cavities, such is found in the karst terrain of southeastern Minnesota, or may occur within a bed where pore fluids have preferentially dissolved out minerals, fossils or other miscellaneous constituents. As mentioned in the section describing mafic rocks above, voids can also result from trapped gases in a magma that may cool to form vesicular basalt, which, in turn, can form amygdaloidal basalt. Another term often used to describe porous carbonates, particularly dolostones in the Prairie du Chien Group, is **oomoldic**. Oomoldic porosity is the result of dissolution of many tiny ooliths within the rock mass.

Term	Description
Pit	A void barely seen with the naked eye. Up to 0.25 inches in diameter (6 mm)
Vug	Voids 0.25 in to 2 inches in diameter (6 mm - 50 mm)
Cavity	Voids 2-24 inches in diameter (50 mm – 600 mm)
Cave	Voids larger than 24 inches in diameter (600 mm)

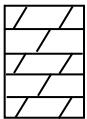

DOLOSTONE, slightly weathered; thin bedded; **vuggy and scattered pitted zones**; brecciated @ 5.9ft; mod hard to hard; lt grey

Miscellaneous Constituents

Miscellaneous constituents include rock characteristics which cannot be categorized according to the accepted list of rock characteristics and may or may not be frequently found in the rock mass. Examples of miscellaneous constituents may include a dominant mineral species, fossils, and the presence of nodules or clasts, paleoenvironmental remnants such as bioturbation or structural vestiges such as brecciation or faulting.

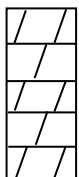

DOLOSTONE, slightly weathered; very thin to thin bedded; vuggy; fractured w/sealed cracks; **chert from 2.3ft to 2.5ft and scattered argillaceous dolostone nodules**; moderately hard to hard; pale yellow brown

Hardness

Rock hardness is a measure of rock strength, and is controlled by many factors including degree of induration, cementation, crystal bonding, and/or degree of weathering. Rock hardness can be determined through manual or laboratory testing of

samples. Rock hardness tests should be performed when it is apparent that rock strength has changed as a result of weathering or change in lithology. The table below lists the various degrees of hardness adopted by the Geology Unit; the degree of hardness to be chosen for the rock lithology will be based on the criteria found to the right of each hardness descriptor. **Rock hardness measurements should be obtained from samples which are representative of the rock mass. Therefore, rock acquired from split tube samples is generally not tested for rock hardness.**

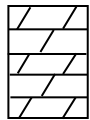

DOLOSTONE, slightly weathered; thin bedded; vuggy and scattered pitted zones; brecciated @ 5.9ft; **moderately hard to hard**; light gray

Table 5-11: Scale of Relative Rock Hardness	
Term	Field Identification
Extremely Soft	Loose sand to soft core, crumbles or falls apart (very friable) upon removal from core barrel/split tube, or under slight pressure; uncemented sandstone
Very Soft	Can be indented with difficulty by thumbnail. May be moldable or friable with finger pressure. In outcrop, can be excavated readily with point of geology pick. Sandstone can be deformed or crushed with fingers.
Soft	Can be scratched with fingernail. Can be peeled with a pocketknife. Crumbles under firm blows with geology hammer/pick. Sandstone cannot be deformed with finger, but grains can be rubbed from surface and small pieces can be crushed between fingers with some difficulty.
Moderately Hard	Cannot be scratched with fingernail. Can be peeled with difficulty by a pocketknife. Specimen can be fractured with a single firm blow of geology hammer/ pick. Sandstone can be scratched with a knife; grains do not rub off surface.
Hard	Can be scratched by knife or geology pick only with difficulty. Several hard hammer blows required to fracture specimen
Very Hard	Cannot be scratched by knife or geology pick. Specimen requires many blows of hammer to fracture or chip. Hammer rebounds after impact.

g.) Color

Color varieties used in descriptions can be found in the color chart created by the Geological Society of America and provided by the Geology Unit. Though the classifier is encouraged to use this color scheme in descriptions, **discretion** with color designation is granted to the classifier as long as consistency is adhered to in subsequent samples, particularly those taken for the same project. **The process of color designation should also be performed on a wet rock face that has been scrubbed clean of debris and drilling fluids.**

To maintain brevity in the past while writing the description some shorthand versions of adjectives and colors have been accepted. These abbreviations will be encountered in older boring logs, however, with larger space allowed for text in the updated versions of gINT the Geotechnical Section is moving away from abbreviations and is currently recommending that they be *avoided* unless the description space requires it. Please contact the Geology Unit with any questions regarding historic borings and abbreviations.

Color	Abbreviation
Brown	brn
Dark	dk
Black	blk
Light	lt
Orange	orng
Yellow	yel
Green	grn



WEATHERED GRANITE; mod hard; **gray-pink w/some dk grn**

Rock Mass Characteristics

Structural elements of rock core are assessed in an attempt to define the overall engineering characteristics of the rock mass. Discontinuities are the major elements of rock mass classification (see discussion of discontinuities above). The properties of geologic discontinuities are evaluated via measurements taken in core samples, including: **Average Core Length (ACL)**, **Rock Quality Designation (RQD)** and **Fractures per Three-Foot (One-Meter) Interval**. **Core Recovery** is also measured

and describes to some degree the properties of discontinuities but is more pertinent in characterizing other properties of the rock mass, such as presence of voids. ACL, RQD, Fractures per Interval and Core Recovery values are determined for each **core run** and are noted in both the original driller's log and on the gINT log. Care should be taken to ensure that the proper units of measure (English or Metric) are being employed while determining discontinuity properties since unit specifications may vary from project to project.

Core Recovery

Core recovery is the percentage of rock core retrieved from a core run divided by the total length of the core run. This is often an indicator of rock quality; with higher percentages suggesting a more intact rock mass. The total length of a particular core run can be found in the original driller's log. In most cases the length of the core run will be similar or equal to the length of the core barrel used; 5 or 10 feet. However, some core run lengths will vary due to conditions encountered while drilling (such as blockage in the barrel). Percentages should be rounded to the nearest whole number. Occasionally, a small piece of core will be left in the hole from the previous run, and this piece may become part of the new run, yielding greater than 100% recovery. Often, this "extra" piece of core has markings on it from the previous core run indicating that it has

Figure 5-5: Sample Core for RQD Calculation

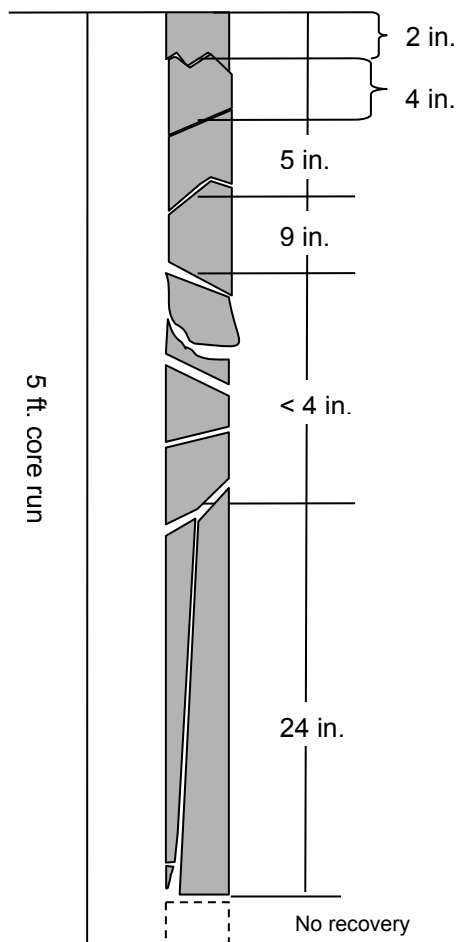

been double-cored. In such instances, the extra core piece should be considered as part of the previous run, and core recovery calculations should not yield results >100%.

Rock Quality Designation (RQD)

Rock Quality Designation is the percentage of intact and sound rock retrieved from a borehole of any orientation. All pieces of intact and sound rock core equal to or greater than 4 inches (100 mm) long are summed and divided by the length of the core run. This procedure follows the *ASTM D6032-02 Standard Test Method for Determining Rock Quality Designation (RQD) of Rock Core*. RQD is a basic component of many rock mass classification systems used for engineering purposes. It has been widely used as a warning indicator of low-quality rock zones that may need more investigation, or careful design considerations. RQD is to some extent dependent on drilling procedures. It was originally developed for NX-size core (2.16 in. diameter) obtained with double-tube core barrels. Core sizes from BQ to PQ with core diameters of 1.44 in. (47.5 mm) and 3.35 in. (85 mm) are normally acceptable for measuring RQD as long as proper drilling techniques are

used that do not cause excessive core breakage. The NX-size (1.16 in.) and the NQ-size (1.87 in.) are the optimal core size for measuring RQD.

There are several ways to define a core run for calculating RQD: 1) a core run is equal to a drill run; 2) a change in formation or rock type could constitute an end of a core run; and 3) a core run can be a selected zone of concern. If a procedure other than the standard drill run is used, it should be clearly documented on the final log.

Man-made core breaks, such as those created by drillers to allow the core to fit in the core box, are not considered natural breaks. Field crew chiefs have been instructed to draw a line (grease pencil or permanent marker) across any intentional core breaks to denote the presence of a manmade break. Additionally, fresh breaks can also occur during the drilling process or during transport of the core. Ideally, these breaks would not be considered in the calculation. However, since an eyewitness was not present to observe these breaks it has been accepted as standard practice to consider these types as natural breaks. Fresh breaks that are created by field personnel or by drilling operations ARE NOT considered natural breaks when calculating RQD.

Core segments are measured internally along the longitudinal axis of the core. A 'Core Break' results when a fracture/joint plane intersects the longitudinal axis of the core.

RQD calculation is easily performed when horizontal discontinuities are present. However, particular attention should be paid to the location of the longitudinal axis-discontinuity intersection when dealing with steeply dipping fractures since a vertical fracture *may not* intersect the longitudinal axis of the core.

Below is an example calculation of RQD using the above core. Note how the lengths are calculated along the longitudinal axis of the core:

$$\text{RQD} = \frac{\sum \text{Length of Intact and Sound Core Pieces} > 4 \text{ in}}{\text{Total Length of core run, in}} \times 100\%$$

$$\text{RQD} = \frac{24+9+5+4}{60} \times 100\%$$

$$\text{RQD} = 70\% \text{ (Fair)}$$

Percentages should be rounded to the nearest whole number.

RQD has been related to the overall engineering quality of the rock, with higher values indicating more intact and better performing rock. This relationship is shown below:

RQD %	Rock Quality
0-25	Very Poor
25-50	Poor
50-75	Fair
75-90	Good
90-100	Excellent

RQD may not be applicable for rocks of very low strength, fissile or foliated rocks (such as shales), as over time they may break apart easily, making identification of natural versus mechanical breaks nearly impossible. Therefore, it is recommended that the RQD for these rocks be done on site as the core is retrieved before slaking, desiccation, stress relief cracking, or swelling can begin. Pieces of core that are highly weathered or severely weathered, are very porous, or are friable should also not be used. For these rocks, the acronym 'NA' should be inserted into the RQD column. It has also been proposed that when a core run contains both a 'sound' rock type and a friable or highly fractured rock type, RQD may be calculated for the length of sound rock instead of the whole core run. This must be clearly noted in the Remarks Column on the log. RQD measurements assume core recovery is at or near 100%.

Core Breaks

Core Breaks, or 'fractures per three-foot (one meter) interval', refers to the total number of fractures that occur in a three-foot interval of core. The rules for defining a core break for ACL and RQD determination also apply to 'Core Breaks' determination. **Intervals with more than fifteen discontinuities are recorded as '>15'**. Zones within a three-foot (one-meter) interval that have more fractures than can be readily measured are designated as '**rubble**'. For core runs yielding core recoveries less than 75% the number of core breaks is not calculated and the acronym, '**NA**' (Not Applicable), is inserted into the 'Core Breaks' column. Occasionally, the boundaries of a void or unrecovered zone can be identified based on the driller's notes in the boring log. These boundaries can be drawn in the 'Core Breaks' column and designated as 'void' or 'NA', and the number of core breaks above and below the void or unrecovered zone can be counted and noted regardless of the 75% recovery criteria (see sample log below).

Average Core Length (ACL)

Average Core Length is the *average* length of core segments found to be greater than or equal to 4 inches (100 mm) in a core run. This value (expressed in either *feet* or *meters*) is a further indication of the relative spacing of the discontinuities, and is calculated for each core run. **Core segments are measured internally along the longitudinal axis of the core. A 'Core Break' results when a fracture/joint plane intersects the longitudinal axis of the core.** Measurements should be rounded to the nearest hundredth of a foot (meter).

Table 5-14: gINT Log Showing Recovery

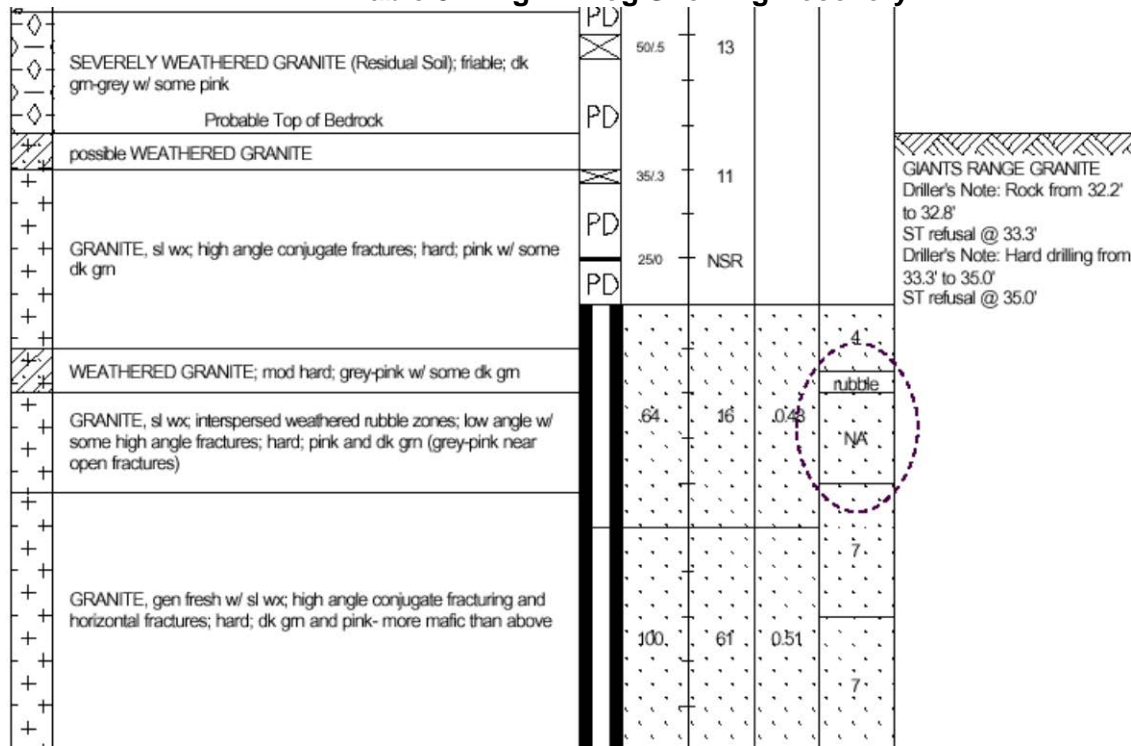

RMR (Rock Mass Rating)

Another method of quantifying rock quality is the **Rock Mass Rating System (RMR)**, also called the **Geomechanics Classification**. This method makes use of many of the rock characteristics described above. Six parameters are used for determining the RMR: 1) Uniaxial Compressive Strength, 2) RQD, 3) Discontinuity Spacing, 4) Discontinuity Condition, 5) Groundwater Conditions, and 6) Discontinuity Orientation. The first five parameters are identified as the basic RMR, which is adjusted by parameter 6) Discontinuity Spacing. Although this method has not been commonly used by the Geology Unit in the past, it may be utilized more often in the design of spread footings and drilled shafts.

The rock mass or core is divided into different structural areas which are classified separately. Boundaries between regions may include changes in rock type, dykes, shear zones, or faults. The first five parameters above are determined for the different regions and are then adjusted by the discontinuity orientation.

RMR does not need to be determined for every rock core sampled. Rock core where RQD is not possible to calculate or where recovery is low should not be given an RMR rating or should be given a rating of Very Poor. It may be necessary to estimate some parameters according to the chart below. Groundwater flow may be difficult to determine from a core but the general conditions may be evident to the driller who will note them on the field boring log.

Table 5-15: RMR Classifications adapted from Z.T. Bieniawski

A.) Parameters									
1	Strength of intact rock material	Point load strength index, MPa (kpsi)	>10 (1.45)	4-10 (0.58-1.45)	2-4 (0.29-0.58)	1-2 (0.145-0.58)	For this low range, uniaxial comp. test is preferred		
		Uniaxial Compressive Strength MPa (kpsi)	>250 (36.25)	100-250 (14.5-36.25)	50-100 (7.25-14.5)	25-50 (3.625-7.250)	5-25 (.725-3.625)	1-5 (.145-.725)	<1
	Rating	15	12	7	4	2	1	0	
2	Drill core quality, RQD (%)		90-100	75-90	50-75	25-50		<25	
	Rating		20	17	13	8		3	
3	Discontinuity spacing, in		>7.2	2.16-7.2	0.72-2.16	0.216-0.72		<0.216	
	Rating		20	15	10	8		5	
4	Discontinuity condition		Very rough surfaces, not continuous, no separation, unweathered wall rock	Slightly rough surfaces, separation <0.039 in, slightly weathered walls	Slightly rough surfaces, separation <0.039 in, highly weathered walls	Slickensided surfaces or gouge <0.19 in thick or joints open 0.039 - 0.19 in continuous		Soft gouge > 0.19 in thick or separation >0.19 in continuous	
	Rating		30	25	20	10		0	
5	Groundwater	General Conditions	Completely dry	Damp	Wet	Dripping		Flowing	
	Rating		15	10	7	4		0	
B. Varying adjustment for joint orientations									
Strike & Dip Orientations			Very Favorable	Favorable	Fair	Unfavorable	Very Unfavorable		
Ratings	Foundations		0	-2	-7	-15	-25		
C. Rock Mass Classes determined from total ratings									
RMR			100-81	80-61	60-41	40-21	<20		
Class Number			I	II	III	IV	V		
Description			Very Good Rock	Good Rock	Fair Rock	Poor Rock	Very Poor Rock		

Another rock mass rating system which may be utilized in the future at MnDOT is the GSI system. This system was created to estimate the reduction in rock mass strength for varied geologic conditions.

5.4 Rock Formations

The name of each rock formation present, if known, is placed on each boring log. Rock formations are classified according to the 2008 Minnesota Geological Survey document *Paleozoic Stratigraphic Nomenclature for Minnesota* and the *Stratigraphic Succession of Precambrian Rocks of Minnesota* except for the Decorah and Platteville Limestone Formations. MnDOT will continue to classify these formations as they are described in the 1987 document due to their engineering properties. Borings classified prior to 2008 will show the older nomenclature and will not be updated. Ongoing projects may, on an individual basis, use the 1987 Formation. If there are any questions regarding the rock formation classification, contact the Geology Unit.

5.4.1 Boring Logs

Final Boring Logs are created for each boring. Like the Field Logs, the final borings include specific information about the boring. An example log is included below. Minimum information that should appear on every boring log is the boring number, project information, location information, elevation, the soil classification, and lab testing results if performed. Drilling and sampling information, water table, and driller's notes should also be placed on the log. They are created using gINT®.

Figure 5-14: Boring Log Example

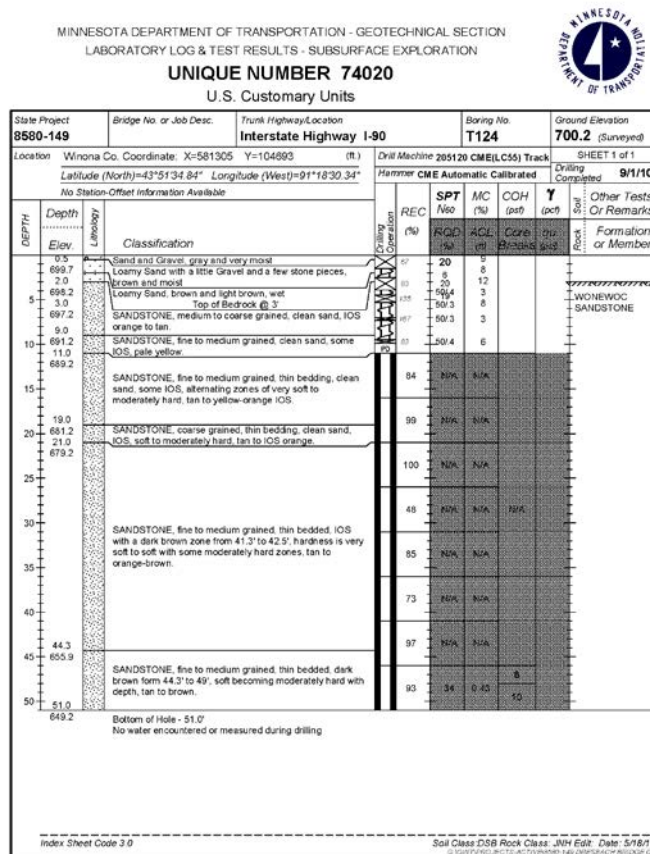



5.4.2 Soil Description

The soil description should include as a minimum:

- Soil type according to one of the classifications based on the MnDOT Textural Triangle
- Additional constituents or descriptions
- Color description
- Water content condition adjective (e.g., dry, damp, moist, wet)

The various elements of the soil description should generally be stated in the order given above. Soil type and additional characteristics are included together; each of the other descriptors should be separated by a comma. When additional information is necessary within a category, such as color description, a semi colon or the word *and* or *with* should be used depending on number of additional descriptors. For example:

	Fine Sand and Gravel with stone pieces, brown and damp
	Fine Sand with Gravel, stone chips and pieces; pinkish-brown and damp

Color

When the color of soil is characterized, only common colors should be used and consistency of color characterization should be practiced. The color should be taken from a moist sample. Colors that are acceptable for soil descriptions include: black, blue, brown, green, gray, red, tan, white, or yellow and can include light or dark as a modifier.

Water Content (Moisture)

The amount of water present in the soil sample or its water content adjective should be described as dry, moist, wet, or saturated as indicated in Table 4-3. Dry soils are usually powdered with no moisture. Damp soils are below the optimum moisture content and may change color when they are exposed to air. Wet soils are between their optimum moisture and saturation, with a high degree of moisture to the touch. Saturated soils will not take extra water and may have water at the surface.

Additional Descriptions

Other aspects of soil that may appear on boring logs may include plasticity, if the soils are slightly plastic or plastic, miscellaneous constituents such as a soil with broken fragments of rock, the compactness of the soil, and soil structure.

5.4.3 Logging Procedures for Core Drilling

Core drilling is performed by the Foundations Unit Drill Crew or by consultant drill crews for geotechnical investigations. Full classification of rock types during drilling is not expected, however, any items of note or changes that occur during drilling should be logged. For example, information such as visible change in rock type, void spaces, and changes in drilling ease or difficulty should be noted on the field log. Field logs are described in detail in previous sections. Geologic descriptions of rock core are performed in the lab by the MnDOT Geology Unit.

5.5 Quarry Studies

As outlined in the 2005 MnDOT Standard Specifications for Construction aggregate classes are defined by their rock type. Quarry studies are conducted by the Geology Unit to determine the rock type or types present within a specific quarry in order to assign a classification based on MnDOT specifications. Requests for studies are generally made by the District Materials Engineer. Studies may also be undertaken in an existing quarry when questionable material is produced.

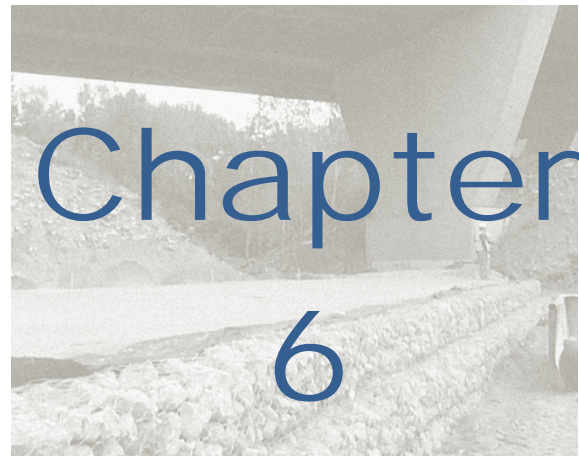

6 Geotechnical Analysis

This chapter deals with the geotechnical design of foundations for structures including bridges, culverts, retaining walls, and noise walls. Shallow and deep foundations are addressed. Current MnDOT practice is to use the Load and Resistance Factor Design (LRFD) methodology for foundation design whenever practical (where design methods and codes exist). The basic equation for the LRFD method is:

$$\Sigma \eta_i \gamma_i Q_i \leq \phi R_n = R_r$$

where: η_i = a factor that includes the effects of ductility, redundancy, and importance

γ_i = the load factor for a particular load

Q_i = a service level load

ϕ = the resistance factor

R_n = the nominal resistance

R_r = the factored resistance

Effective foundation design requires communication between the geotechnical engineer and the structural engineer, so the design procedures presented here are developed to address what information is needed along with when and how information will be exchanged.

6.1 Design Involvement

Designers should ensure that the project schedule has activities for geotechnical field investigations and recommendations for structures such as bridges, culverts, walls, specialty slopes, and large embankments. Geotechnical investigations are also frequently appropriate for structures and features that are large in extent or located near or over problematic soil deposits or hydraulic features.

Typically the geotechnical section will do geotechnical investigations and prepare and issue reports for:

- 1) Scoping projects to determine geotechnical conditions on new alignments
- 2) Bridge foundation expansions or new foundation construction
- 3) Tunnels
- 4) Large box culverts
- 5) Smaller culverts with specialty design or construction considerations
- 6) High/Tall embankments
- 7) Embankments or roadways over soft soils or organic materials
- 8) Retaining walls
- 9) Noise walls.
- 10) High-mast light towers and radio towers
- 11) High tension guardrail end anchors
- 12) MnDOT buildings (i.e. maintenance shops and rest areas)
- 13) Slopes (including cut and fill slopes in soil and rock)
- 14) Reinforced slopes
- 15) Construction in problematic soils or unusual soil conditions
- 16) Foundation elements for large signs
- 17) Specialty foundation topics (historic or environmentally sensitive sites)

It is important to note that perhaps unlike some other design aspects, geotechnical investigations are highly site specific and information is spatially relevant. Proximity of soil borings [or other investigation techniques] is important and sometimes critical to providing an efficient and functional design. This may be especially true in environments where rock or soft soils are present. For this reason, site investigations should be conducted when foundation locations and elevations are established with some certainty. There are relatively high costs associated with field investigations and associated sampling and testing. It is recognized that there needs to be some accommodation for design elements that shift during the course of the design process, however, to the extent that significantly relocating structures can be minimized, this often saves considerable geotechnical field effort. Similarly, if all the structures in an area can be identified early, there are economies in investigating sites thoroughly at one time rather than remobilizing to a site on several subsequent occasions. If possible design changes are known at the time of the initial investigation, this information should be passed along to geotechnical personnel to aid in the investigation planning. Collaboration among project designers and the geotechnical group is encouraged.

Some projects are of such a size or significance where a risk analysis may be prudent and additional investigation and analysis, beyond the standard level of care, may be useful.

6.2 LRFD

The concepts behind LRFD are explained in various FHWA and AASHTO publications. In general, the intent is to harmonize the design of constructed works such that there is a consistent level of risk and reliability throughout the structure such that any one

component is not significantly oversized and that particular design features are robust and redundant enough to result in an efficient, economical, and safe structure.

6.2.1 Limit States

There are three general design 'limit states' considered from a geotechnical standpoint, consistent with structural considerations, which include strength, service, and extreme events.

Strength: Geotechnical strength is the amount of available support that the earth can provide to a shallow, deep, or hybrid foundation system. Note that there can be several potential failure conditions and that exceeding the geotechnical strength limit will not necessarily result in collapse (although this is typical of slope stability cases), but usually in unacceptable service conditions for foundation systems.

Service: The service limit is often a deformation controlling criterion. Usually, a structure will have a tight service limit tolerance and in soil this condition will tend to govern the design of shallow foundations and some deep foundation systems (such as large drilled shafts). In some circumstances, such as strong unjointed rock, which deforms relatively little under load, the strength limit is likely to govern.

Extreme Event: In some cases, the critical design may be one where support is removed by flooding, erosion, or other unusual forces (vessel impact, blasting, earthquake, etc...). Typically, these are specialty site-specific cases.

6.2.2 Resistance Factors

Depending on various aspects of the site, investigation practice, and construction practice, different resistance factors may be appropriate for application to a project design. Shallow foundation resistance factors are generally dependent on investigation methods, drilled shaft resistance factors are based on design methodology and field testing. Driven pile foundations, perhaps the most complex in terms of LRFD resistance factor options, may have resistance factors based on static methods, WEAP analysis, dynamic-formula field construction control methods, field testing with sensors and high strain dynamic monitoring and wave mechanics analysis, or these techniques in combination with field load testing.

Resistance factors will be recommended in geotechnical reports based on investigation techniques, project size, potential project and program benefit from high-quality construction control, time, economy, research needs and opportunities, and design/construction constraints. In some circumstances, specialty testing (such as PDA/CAPWAP or Static Load Tests) will be recommended for projects; these recommendations will be coordinated with design and construction groups in the Bridge Office, and District design and construction personnel.

Locally Calibrated Resistance Factors

At this time, MnDOT is applying the load factors which are designated in the current AASHTO code, supplemented by locally calibrated resistance factors for the new dynamic driving formula, MPF-12. Studies are under way to potentially derive and adopt a local calibration for use with shallow foundations as recent monitoring programs have shown design methods (and their associated resistance factors) to be generally highly conservative.

The geotechnical section should be consulted for projects where the adoption and use of resistance factors may be unclear or subject to implications from construction quality control such as when micropiles or quasi-static load testing (among others) are used.

6.3 Shallow Foundations

One definition of a shallow foundation is one that bears at a depth less than about two times the foundation width. Shallow foundations are generally less costly than deep foundations. Shallow foundations are not used in soils with insufficient bearing capacity, in soils where settlement exceeds the tolerance of the supported structure, where differential settlement exceeds the tolerance of the structure, or where excessive scour or erosion could endanger the integrity of the foundation.

The following procedure (based on the procedure found in the FHWA publication **GEOTECHNICAL ENGINEERING CIRCULAR NO. 6, Shallow Foundations**) is recommended to facilitate the communication between the structural engineer and the geotechnical engineer;

- 1) The Preliminary Bridge design Unit will provide the following; a preliminary bridge layout including the location and anticipated elevations of the substructures (abutments and piers), preliminary design loads at each substructure, and criteria for tolerable settlement.
- 2) The Foundations Unit will conduct a site investigation including assembling existing information (borings, geologic information, etc.), site reconnaissance, subsurface exploration and laboratory testing. When shallow foundations are anticipated, it is often necessary to take additional borings to determine consistency of the foundation material. Settlement predictions based on standard penetration testing (SPT) have been shown to often be overly conservative. As a result, in situ testing methods, such as flat plate dilatometer (DMT), cone penetration testing (CPT) with seismic measurements, and pressuremeter testing are being used more frequently to provide more realistic settlement predictions.
- 3) The geotechnical engineer assigned the project will review the information and determine if a shallow foundation is feasible or if a deep foundation is needed.
- 4) If a shallow foundation is feasible, the geotechnical engineer will do the following; calculate the nominal bearing resistance at the strength and extreme limit states,

calculate sliding and passive soil resistance at the strength and extreme limit states, and check global stability using service (unfactored) loads.

- 5) The geotechnical engineer will prepare foundation recommendations including the following information for the shallow foundation design; a chart showing the service limit state nominal bearing resistance vs. effective footing width for the settlement criteria, a chart showing the nominal bearing resistance at the strength limit state, and the equation (along with assumptions regarding use of passive pressure) for calculating nominal sliding resistance.
- 6) The regional bridge engineer will prepare final foundation recommendations using information contained in the foundation report.
- 7) The structural engineer will size the footing at the service limit state; check the bearing pressure, eccentricity, and sliding resistance at the strength limit state; and complete the structural design of the footing using factored loads.

An example foundation report for a shallow foundation is included in the electronic documentation appendix.

6.4 Ground Replacement or Improvement for Shallow Foundations

As shallow foundations are usually more economical (especially for embankments, culverts, and other small structures, if settlement predictions indicate that the anticipated ground deformations will exceed the tolerances, ground replacement or improvement techniques may be used.

These techniques consist frequently of removing and replacing native soils or improving soils by introducing sand, gravel, rock, or cementitious mixtures (with or without compaction) usually by means of relatively sophisticated techniques and specialized machinery and tooling. Stone columns, rammed aggregate piers, deep mixing methods, grouting, and other techniques may be used. Often these techniques are not economical for the relatively small footprints of bridge foundation elements, but are more practical economical than driven piles or drilled shafts for large areas, especially where deformation tolerances may be less rigorous (for walls and roadways as an example).

6.5 Deep Foundations

Deep foundations are used when a shallow foundation is either not feasible or is believed to pose a problematic project risk due to future excavations, scour, or other potential circumstances where the foundation support may be compromised. Cast-in-place pipe pile (steel shell pile infilled with concrete), H-pile, and drilled shafts are the most common choices for deep foundations for MnDOT bridges. In some cases, especially retrofitting existing structures, newer techniques such as micropiles are appropriate.

Although not in wide use yet at MnDOT, precast concrete pile, concrete cylinder pile, and auger-cast piles and similar techniques are becoming more common for foundation support due to material and installation economies associated with these systems.

6.6 Hybrid Foundations

Though not in common use, hybrid foundations such as pile supported shallow foundations, mats, and rafts, or combination foundation systems can be used to provide foundation support when deep foundation systems may not be economical and shallow foundation systems may result in excessive or undesirable settlement.

Settlement mitigation platforms (mats and pile rafts) have been constructed successfully for the support of culverts and roadway embankments at MnDOT.

6.7 Pile Foundation Design

The following procedure (based on the procedure found in the **WASHINGTON STATE DOT BRIDGE DESIGN MANUAL**) is recommended to facilitate the communication between the structural engineer and the geotechnical engineer;

- 1) The Preliminary Bridge design Unit will provide the following; a preliminary bridge layout including the location and anticipated elevations of the substructures (abutments and piers), preliminary design loads at each substructure, and criteria for tolerable settlement.
- 2) The Hydraulics Unit will provide a report including the hydraulic requirements of the structure and a prediction for potential scour depth.
- 3) The Foundations Unit will conduct a site investigation including assembling existing information (borings, geologic information, etc.), site reconnaissance, subsurface exploration and laboratory testing.
- 4) The geotechnical engineer assigned the project will review the information and determine if a deep foundation is needed and if piling is the recommended foundation type.
- 5) If a pile foundation is recommended, the geotechnical engineer will calculate the nominal bearing resistances of the recommended pile types and dimensions. The geotechnical engineer will prepare foundation recommendations including the following information; recommended pile types and dimensions and a graph of the calculated nominal capacities versus depth for each substructure and each pile type and dimension considered.
- 6) The geotechnical engineer will recommend field control methods along with the associated phi factors corresponding to the field control method.
- 7) The geotechnical engineer will address any other issues associated with the pile including the potential for downdrag and the associated value for downdrag, the potential for setup along with the estimated rate and amount of anticipated setup, and the potential for relaxation and the estimated amount of relaxation.

- 8) The geotechnical engineer will provide P-Y curve parameters for pile lateral load analysis when appropriate.
- 9) The regional bridge engineer will prepare final foundation recommendations using information contained in the foundation report.
- 10) The structural engineer will use the foundation recommendations to determine the number of pile required and complete the substructure design.

An example foundation report for a pile foundation is included in the appendix.

6.8 Drilled Shaft Design

The following procedure (based on the procedure found in the **WASHINGTON STATE DOT BRIDGE DESIGN MANUAL**) is recommended to facilitate the communication between the structural engineer and the geotechnical engineer;

- 1) The Preliminary Bridge design Unit will provide the following; a preliminary bridge layout including the location and anticipated elevations of the substructures (abutments and piers), preliminary design loads at each substructure, and criteria for tolerable settlement.
- 2) The Hydraulics Unit will provide a report including the hydraulic requirements of the structure and a prediction for potential scour depth.
- 3) The Foundations Unit will conduct a site investigation including assembling existing information (borings, geologic information, etc.), site reconnaissance, subsurface exploration and laboratory testing.
- 4) The geotechnical engineer assigned the project will review the information and determine if a deep foundation is needed and if drilled shafts are the recommended foundation type.
- 5) If a drilled shaft foundation is recommended, the geotechnical engineer will calculate the nominal single shaft bearing resistance at the strength and extreme limit states as a function of depth, for likely shaft diameters. The geotechnical engineer will prepare foundation recommendations including the following information; recommended shaft diameters and recommended depths, estimated downdrag loads, estimated settlement, estimated uplift resistance as a function of depth, and P-Y curve parameters for shaft lateral load analysis.
- 6) The geotechnical engineer will recommend field control methods along with the associated phi factors corresponding to the field control method.
- 7) The geotechnical engineer will address any other issues associated with the drilled shaft design and construction including recommendations related to integrity testing, such as cross hole sonic logging or gamma- gamma logging and definitions needed for quantities such as what obstructions may be encountered and what will be considered rock excavation.

- 8) The regional bridge engineer will prepare final foundation recommendations using information contained in the foundation report.
- 9) The structural engineer will use the foundation recommendations to determine the number of drilled shafts required and complete the substructure design.

An example foundation report for a drilled shaft foundation is included in the appendix.

6.9 Dragload and Downdrag

A new design policy has been developed and is available on the Geotechnical Section webpage. Noting that this phenomenon can also act on drilled shafts, it will be discussed here with reference to driven piles.

Pile dragload is additional load imparted into a deep foundation pile, along a given length of the pile in the soil. This load is not imparted by traditional 'structural loading' and is not imparted at the pile head or along the length of the pile embedded in the structure. Downdrag is the more common term as a general description for the phenomenon of pile settlement (deflection) and the related load that causes this 'downdrag' movement. Many references separate these parameters and that convention is adopted here where 'dragload' is the force that causes the 'downdrag' displacement.

The soil surrounding a pile can move in relation to the pile due to fill being placed, the groundwater being lowered, the pile being driven into fill material that hasn't had time to consolidate, or other causes (such as the driven pile installation process itself). The soil in upper near-surface layers tends to adhere to the pile, and transfer load to the pile. As described above, this added soil load is known as 'dragload'. When the pile is driven into rock or a very dense layer, the pile cannot move and the dragload must be taken in to account in the design requirements for the structural capacity of the pile.

If conditions are such that the pile can move in response to this added loading, settlement of the pile becomes a concern. This settlement (movement) is known as downdrag.

6.9.1 Dragload Considerations

Recent work by other authors and ongoing field studies at MnDOT suggest that dragload and downdrag effects are more prevalent than previously appreciated, although from a "practical" standpoint the magnitudes of the forces are usually within the safety margins and conservatism required by proper application of the LRFD code for bridges founded on piling. The deformations are frequently small or mitigated by time-domain benefits of typical construction sequences.

Recent changes in MnDOT practice, where more available pile capacity is being utilized for greater economy and effectiveness, have resulted in an improved understanding of the mechanisms and implications of dragload and downdrag. Whereas in the past, there was a significant amount of design conservatism to accommodate unanticipated (or completely ignored) dragload/downdrag impacts, this excessive conservatism is being reduced by improved practice and application of the LRFD code.

6.9.2 Mitigation Strategies

The pile must be designed to structurally accommodate the dragload (when driven to a hard layer) or the superstructure to be able to withstand the settlement (including potential differential settlement) due to the downdrag that will occur (when not driven to a hard layer).

6.10 Culverts

The Geotechnical Section investigates and prepare recommendations for large box culverts (80 ft² opening or larger) as a matter of general policy. The recommendations will include an analysis for bearing capacity, settlement, and slope stability. In some cases, based on the geotechnical site investigation, recommendations regarding inlet/outlet protection, wingwalls, dropwalls, liners, related features, and construction considerations may be appropriate and provided.

Culvert investigations may be provided for smaller structures by request from the District design or construction groups if the culverts have unusual design features such as being constructed below high earth fills, within unusual materials, or over poor or problematic soil deposits.

6.11 Construction in Problematic Geotechnical Conditions

Either as an independent report, or as a component of a site investigation and analysis, construction in problematic site conditions may be addressed. Organic soils, peat, marl, unstable soils, and compressible clay deposits are the most frequently encountered problematic site conditions. Other special cases exist such as locations susceptible to or part of existing soil or rock failures, potential loss of ground by erosion, presence of karst and similar rock formations, and construction in low-headroom or other challenging circumstances. Complex sites requiring staged construction, special construction techniques (such as dewatering, pre-loading, ground improvement, or blasting), or other specialty treatments may also merit a special analysis and report.

6.12 Construction Analysis, Reporting, and Recommendations

If appropriate, design, analysis, reporting, preparation of recommendations and specifications, or commentary may be provided for construction sequencing or staging or for temporary works associated with projects. This type of work is usually performed as a special request or as a component of work associated with use and installation of

certain geotechnical solutions in staged construction scenarios such as lightweight fills and construction of reinforced slopes or walls.

6.12.1 Pre-Loading

Examples of specialty projects of this type would be the instrumentation, monitoring, and reporting of a pre-construction embankment pre-load and surcharge for an upcoming bridge project or the review of the appropriateness of a temporary MSE wall system for progressive construction of temporary bridge abutments.

6.12.2 Sheeting/Shoring

If the Bridge Office is involved with sheeting or shoring design, a geotechnical analysis is usually required to provide necessary soil parameters for this work. An analysis may also be conducted for permanent works to ensure the planned construction is functional and safe during long term and extreme event conditions.

6.13 Failures, Project Forensics, and Performance Analysis

At the request of the Bridge Office or District personnel, the geotechnical section participates in the field review and analysis of roadway, embankment, and structural performance problems. Geotechnical and structural features may be deemed poorly performing due to ongoing long-term factors such as creep or progressive strength deterioration caused by ongoing movement.

Many failures are related to erosion or strength loss caused by sudden extreme events or changes in groundwater or surface water features. Other triggers could include vibrations, vessel impact, scour, or progressive degradation or deterioration of reinforcing or fascia elements.

The most common failures are noted in slopes due to natural slope instabilities which have been perturbed by construction or influenced by changes in drainage. The most common failures in walls are generally related to groundwater and drainage. Although failure in bridge geotechnical features are rare, when they do occur it is generally caused by unanticipated (but not usually catastrophic) settlement of a pile group.

Depending on the nature of the work, a report for immediate repair and retrofitting or new construction may be prepared. Alternately, conditions might be such that an investigation program is required. In some cases, further investigation and instrumentation and monitoring program is recommended to better understand the mechanisms and implications at a particular project site. The nature of the work will depend on the project scope, timeline, budget, complexity, and the overall level of risk associated with the work and implications for initial cost, life-cycle cost, performance, maintenance, as well as public safety.

6.14 Embankments & Reinforced Soil Slopes

The Geotechnical Section investigates the soil properties below large embankments and reinforced soil slopes to ensure that the site soils have sufficient bearing capacity and appropriate stiffness/deformation characteristics to support the proposed construction without risk of failure or poor performance due to excessive settlement. Due to the relatively concentrated loads a number of design factors need to be considered including, bearing, settlement, lateral squeeze, and stability (internal, compound, and external/global).

Often, these investigations are performed on request by District personnel after a design has progressed far enough to determine that large embankments or slopes are required or that these features will be located in areas where the in-situ soils are poor or marginal in nature.

Reinforced Soil Slopes (RSS) and special RSS, frequently noted 'RSSS,' are soil slopes that have been built with internal reinforcing elements such that they may be built at relatively steep angles, usually from 45 degrees to 70 degrees. The geotechnical section may provide recommendations related to only the underlying soils, or provide recommendations for the RSS as well, depending on District design needs and the type of project.

It is important to note that although Standard Plans for MSE Walls and RSS slopes are available that a geotechnical investigation is required to confirm that site material properties are adequate to accommodate these standard designs; they cannot be used without appropriate engineering confirmation of site soil conditions. In addition, designers must also be aware that the standard plans have restrictions on their use and applicability. These designs are not appropriate for some site conditions where material properties are poor, where sloping ground (or rock) or unusual groundwater conditions exist and may impact the overall stability of the system.

6.15 Erosion Control

The geotechnical section typically will provide recommendations for specialty erosion control measures if structures may be adversely impacted by hydraulic erosion. This usually applies to, but is not limited to, slope stability projects.

The hydraulics and water resources areas are principally responsible for this area, but in cases where there is significant risk of loss-of-ground or other deleterious effects, aspects of erosion control are incorporated into the geotechnical reports. This may include recommendations for scour and erosion protection, use of geosynthetic separators, filters, or drains, use of swales, pipes, or flumes, or the design of impervious barriers or drainage and filter systems.

Recommendations may include use of geocells or other cellular soil confinement systems, gabion baskets or reventment mattresses, biostabilization, or facing with geotextiles or other semi-permanent or permanent erosion control products.

Recommendations to lower or control groundwater to reduce seepage and potential instability at slope faces may also be included.

6.16 Drainage

The geotechnical section frequently will include recommendations for drainage in geotechnical reports. New drainage details are included in the latest LRFD standard plans for cast-in-place retaining walls.

Improperly designed or installed drainage systems are frequently the cause of retaining wall distress and failure. The importance of a well-designed, functional, drainage system to the performance of most geotechnical works cannot be underemphasized. Seepage forces, hydrostatic pressure, piping, and hydraulic uplift can all cause undesirable impact and sometimes failure. Drainage is relatively inexpensive and easy to inspect, yet it frequently is underdesigned, poorly installed, and poorly inspected. Attention to drainage is imperative in both the design and construction phases and represents a relatively low cost method to improve structural performance and stability.

Where drainage is directed into open channels, appropriate channel protection and liners are to be installed to minimize erosion. Where works are being constructed in cut sections or in locations with large quantities of water introduced by overland flow or through groundwater systems, specially designed drainage systems must be evaluated and appropriately detailed to accommodate these atypical impacts. Herringbone, chimney, French, trench, and other drainage systems are available to help remove water from a project site. There are a large number of specialty drainage products that are also available to meet project specific needs.

6.17 Settlement

The geotechnical section investigates site conditions and provides settlement predictions recommendations and mitigation strategies for projects where excessive settlement is anticipated. This may apply to foundation elements, culverts, structures, embankments, or roadways. Tolerable settlement is based on a number of factors and may be both feature specific and site specific.

6.18 Fill and Cut Slopes

The geotechnical section investigates and provides recommendations for both fill and cut slopes if the slopes are either especially steep or have specialty considerations related to internal or external material properties, geometry, or other unusual project characteristics. Generally, it is the responsibility of District personnel to alert the Geotechnical Section to any needs of this type on a transportation project.

6.18.1 Soil Slopes

The geotechnical section generally investigates steep or reinforced slopes. “Standard” embankment slopes of 2H:1V or flatter are generally left to local District soils and materials groups to consider, investigate, and report if necessary. Exceptions to this general rule are where soft soils, organic materials, compressible soils, or rock are present. Rock slopes are generally considerably more complex and these features are described in the next section. Slopes with very large extent may also be reviewed by the geotechnical section to ensure that there are no problematic design elements internal or external to the slope.

Problems that sometimes occur are related to the significant weight of the large embankment fills or the large surface area of the slope face which can be destabilized with channelized overland flow or the seepage occurs at the face from exiting groundwater which may not have been considered in the original design, depending on where the embankment is constructed.

Fill and cut slopes may also be investigated if they are steep enough to require internal reinforcement and/or specialty fascia. (Refer to Section 6.14).

6.18.2 Rock Slopes

The Geotechnical Section provides rock slope recommendations for new and existing sites where construction requires removal of bedrock in the back slope. Rock slope recommendations are provided for new and existing rock cuts to accommodate new road alignments, widening of roadways, or for stabilizing existing rock slopes or providing improved rock catchment. Rock slope recommendations are based on many different factors, including:

- Rock type
- Discontinuity (bedding, joints, fractures) orientation and frequency
- Cut Height
- Weathering
- Presence of erodable material
- Highway orientation
- Right-of-way
- Aesthetics

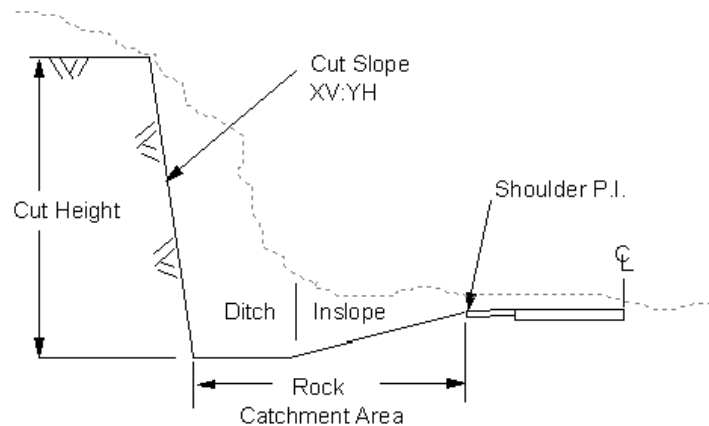
Figure 6-1: rock cut slope diagram

An optimum rock slope design minimizes risk to the public and also minimizes the amount of excavation and stabilization required. Proper design includes selection of an optimum “safe” cut slope angle together with an appropriate rock fall catchment area. Figure X illustrates the terms used in a Rock Slope design. The **cut slope** is often referred to as a “cut slope angle”, but at MnDOT it is expressed as a slope, vertical to horizontal (for example 2V:1H). The **rock catchment area** includes the flat ditch area plus the inslope that ends at the shoulder. The inslope normally varies between 1V:6H and 1V:4H.

Cut slope angles are typically derived from an evaluation of **rock mass characteristics**, which can be attained from a combination of measurement made of exposed bedrock faces and an assessment of rock cores taken by the Foundations Unit. Additional factors that may bear on cut slope selection include site conditions (groundwater, roadway orientation, and others) and experience.

In reality the design process is a tradeoff between stability and economics. Steep slopes and narrow ditches are usually less expensive to construct than the safer and more stable flatter slopes and wider ditches. To a lesser extent, aesthetics may play a role in rock cut designs and can enhance engineering designs. They should not, however, be allowed to dictate the design. In most cases agreeable compromises are possible between aesthetics and safety.

Since the geologic structure and type of rock vary considerably at each individual rock cut (often within the same project), it is difficult to provide general guidelines for design recommendations that fit all circumstances. The following guidelines are created to fit typical conditions common to Minnesota. The Geology Unit should be contacted for site-specific designs. The examples below will consider two general categories of rock based on their ease of excavation. **Soft rocks**, which include principally shale and sandstone, can be excavated without blasting. **Hard rocks**, which require blasting to excavate, include igneous, metamorphic rocks and carbonates.

Low rock cuts (<6 ft in height) can be treated as rock slopes or soil slopes by the designer. Softer rock slopes may be laid back to match existing soil slopes and covered with topsoil and vegetation. In hard rock, blasting of the slope will likely be required. MnDOT specification 2105.3C requires presplitting of hard rock types for any cut slope steeper than 1H:1V. Presplitting of these low cut faces is not necessary from a rockfall standpoint, but will result in a clean, durable rock face that does not deviate significantly from the planned excavation line. Aesthetic considerations such as excavating back to natural discontinuities in the rock face rather than presplitting are allowed, but special provision language will need to be included that excludes presplitting.

Intermediate rock cuts (6 ft to 30 ft in height) should closely follow the design guidelines in the Road Design Manual, Figure 4-6.02, Typical Rock Section, or may employ an alternate design approved by the Geotechnical Engineering Section. Soft rock slopes can be treated as soil slopes with standard ditch sections, in which case they should be covered with topsoil and vegetation. Often, sandstone is exposed in high bluffs where it would be impractical to cut it to a soil slope. In this case it is often desirable to cut the sandstone to a steep slope, such as 4V:1H, and direct runoff away from the face to the extent possible. In hard rock types, controlled blasting techniques are required for final shaping of the cut face. The standard ditch width should be 12 feet, with a depth of 4 feet. Using a standard inslope of 1V:6H or 1V:4H, the resultant rock catchment area (ditch width + inslope) would be 36 feet or 28 feet, respectively. Composite slopes, consisting of both soft and hard rock types (particularly with hard overlying soft) are susceptible to differential erosion and require careful consideration. Typically, the hard rock layer will be set back 10 feet from the face of the underlying soft rock, with an impermeable bench constructed on top of the soft rock layer.

High rock cuts (>30 ft in height) should be investigated and designed by appropriate units of the Geotechnical Engineering Section. Investigation of rock quality and rock mass properties (such as joint orientation and frequency) should be conducted on rock outcrops and rock core samples to design appropriate cut slopes and ditch catchment areas. High rock cuts require controlled blasting techniques to limit rockfall during construction and after completion of the project. For preliminary planning purposes, you may estimate the necessary rock removal/right-of-way by assuming a rock slope of 2V:1H (63°) and a rock catchment area of 35 feet. These will yield conservative values in most cases and should be refined prior to finalizing the design.

Transitions into and out of bedrock, both transverse and longitudinal, should be provided in the design to minimize differential settlement. Provide a minimum of 1:20 taper in the longitudinal and 1:10 taper in the transverse directions. The District Soils Engineer or the Geology Unit can provide recommendations for specific projects.

6.19 Groundwater

Groundwater (or Ground Water) is both a precious resource lying beneath much of the state's land surface and a great engineering challenge to those who encounter it during planning and construction of the state's infrastructure. As a resource, it is worthy of the

extreme care that must be taken to protect it. As an engineering challenge, it can humble even the most experienced designer or constructor, particularly if it catches them by surprise.

“Hydrology is the study of water. In the broadest sense, hydrology addresses the occurrence, distribution, movement, and chemistry of all waters of the earth” (Fetter, 1988). This section will deal with the interaction of water and geologic materials, referred to as **hydrogeology**.

Water that reaches the earth’s surface will either drain across the land via some type of surface drainage regime, or will infiltrate into the subsurface. Infiltrated water is given the name **subsurface water**, and it includes water in the zone of aeration (unsaturated zone), where it is called **vadose water**, and water in the zone of saturation, known as **groundwater**. The **capillary fringe** consists of vadose water held immediately above the saturated zone by capillary forces, the height of which depends on the diameter of the pore spaces in the material.

Figure 6-2: Subsurface water diagram

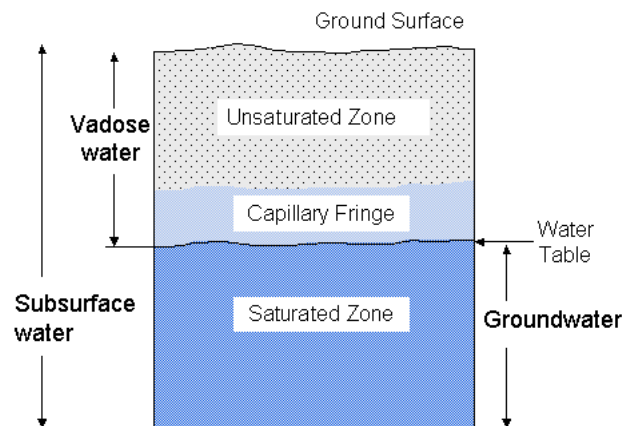

An **aquifer** is typically defined as a saturated rock or soil unit that is sufficient in both permeability and extent to transmit economic quantities of water to wells or springs. The term is relative to other available sources of water and to the quantity of water required. Thus, a formation that is an aquifer in one situation may not be so in another. Unconsolidated sands and gravels, sandstones, carbonates, basalt flows, and fractured igneous and metamorphic rocks are examples of geologic units known to be aquifers.

The usage of the term aquifer in regards to water supply requirements makes it difficult and misleading to use in discussions of general subsurface water occurrence. A more appropriate term for use in highway construction would be **water-bearing zone** (or layer), which may be defined in a broader sense as being any geologic formation or stratum, consolidated or unconsolidated, or geologic structure (such as a fracture or fault zone) that is capable of transmitting water in sufficient quantity to be either of use or of concern.

A **confining layer** is a geologic unit having low permeability in comparison to a stratigraphically adjacent water-bearing zone. There are very few, if any, geologic formations that are absolutely impermeable. Weathering, fracturing, solution, and biological disturbance have affected most rock and soil units to some degree. However, the rate of groundwater movement in these units can be exceedingly slow. Typical geologic materials that make up confining beds are clays, tills, shales, and igneous and metamorphic rock units that are not extensively fractured.

Water-bearing zones (aquifers) can be classified on the basis of the presence or absence of an overlying confining bed, and the resultant **potentiometric surface** - which is defined as the level to which water will rise in a tightly cased well. A water-bearing zone with no overlying confining layer will have a potentiometric surface that is equal to the atmospheric pressure. This type of system is known as an **unconfined or water table aquifer**, and the potentiometric surface is often called the **water table**. Recharge to this type of aquifer can be from downward seepage through the unsaturated zone, through lateral groundwater flow, or by seepage from underlying strata.

Perched groundwater is unconfined groundwater separated from an underlying body of groundwater by an unsaturated zone. It occurs when subsurface water percolating downward is held by a bed or lens of low-permeability material. Perched groundwater may be either **permanent**, where recharge is frequent enough to maintain a saturated zone above the perching bed, or **temporary**, where intermittent recharge is not great or frequent enough to prevent the perched water from disappearing with time as a result of drainage over the edge or through the perching bed.

Figure 6-3: Schematic Illustration of the Occurrence of Groundwater in an Unconfined (Water Table) System (Adapted from FHWA, "Highway Subdrainage Design")

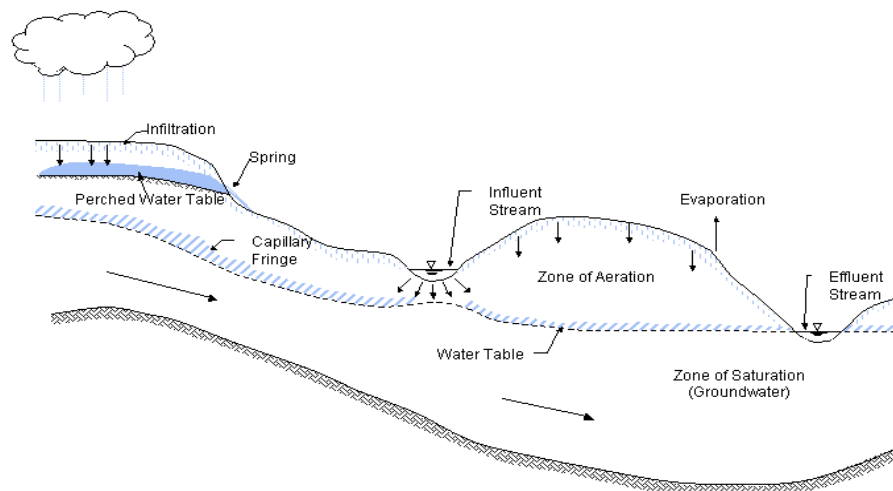

A water-bearing zone with an overlying confining layer and a potentiometric surface that rises above the base of the confining layer is known as a **confined** or **artesian aquifer**.

When the potentiometric pressure is sufficient to raise the water level above the ground surface, it is referred to as a **flowing artesian** condition. Recharge to confined aquifers generally occurs some lateral distance away, where the aquifer is not confined.

Figure 6-4: Confined Aquifer (artesian flow conditions) Adapted from FHWA, "Highway Subdrainage Design"

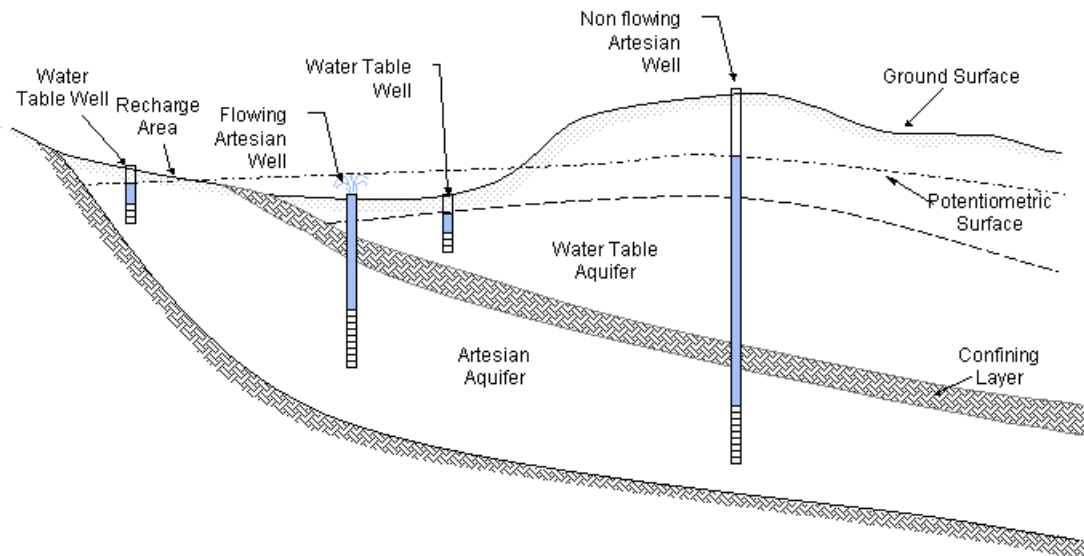

6.19.1 Groundwater Occurrence

Differing geologic features and land forms of Minnesota cause significant differences in groundwater conditions. Minnesota is situated on the southern margin of the Canadian Shield, which is a region of Precambrian crystalline and metamorphic rocks. In Paleozoic times, nearly 2,000 feet of clastic and carbonate sediment were deposited in a shallow depositional basin known as the Hollandale embayment. During the Cretaceous period, shallow seas again deposited a layer of sediment, mainly in the southwestern and extreme western portions of the state. During the Pleistocene Epoch, four continental glaciations advanced and retreated across Minnesota, blanketing the bedrock with drift as thick as 600 feet. Sand and gravel deposits in the drift constitute important aquifers, particularly in western Minnesota where the drift is thickest and where bedrock aquifers have small yields.

Quaternary Hydrogeology

Surficial drift aquifers are exposed at or near the land surface and cover a large portion of the central part of the state. These aquifers consist of alluvial outwash, beach-ridge, and ice-contact deposits. Extensive outwash deposits are a significant source of water and are potential problems for construction excavation and dewatering.

Buried drift aquifers are present in nearly all areas of the state, except in the northeast and southeast where the drift is thin or absent. The aquifers consist of discontinuous layers of fine to coarse sand and gravel that are isolated from one another by till. Where they have sufficient aerial extent, these aquifers are a good source of moderate to high volumes of water. Occasionally, these aquifers are confined and produce flowing artesian conditions when encountered during pile driving or structure excavations.

Alluvial aquifers consist of sand and gravel locally interbedded with silt and clay. They are found in present-day river valleys and buried river channels, and include river terrace deposits. These aquifers are often very prolific producers, and can be difficult to dewater for construction of bridge piers and abutments. The layered nature of the deposits along with the typical river valley topography often yields significant artesian conditions that must be addressed during the subsurface exploration program.

Bedrock Hydrogeology

Only in the southeastern portion of the state are the bedrock aquifers prolific water producers. These Paleozoic sedimentary formations (such as the St. Peter sandstone, Prairie du Chien dolostone, Jordan sandstone, etc.) can be a potential source of problems for construction dewatering because of their proximity to the surface in many locations. Also, because these formations are used extensively for water supply, care should be taken to limit their exposure to contamination from construction activities or from removing overlying confining beds.

Elsewhere in the state, bedrock aquifers are typically low yielding and are used only because of the absence of Quaternary aquifers. These aquifers generally have little impact on construction projects, but care must be taken to limit impact to wells completed in these aquifers.

More detailed information on the hydrogeology of specific areas within Minnesota can be obtained from the Minnesota Geological Survey on-line publications at: <http://www.mnngs.umn.edu/index.html>

Analysis

Groundwater analysis should provide information necessary to design a subsurface drainage system. Information such as hydraulic conductivity, aquifer thickness, and gradation of aquifer materials, are generally necessary for design of the permanent groundwater control system.

Basic information can be gained from geologic mapping, borehole drilling logs, or CPT logs. Hydrologic maps exist for much of the state. These maps may show contours of depth to groundwater or an aquifer thickness map. Mapping may also provide regional groundwater flow direction and aquifer properties. Drilling will give an idea of the water level at the specific time of drilling and provide soil and/or rock samples for testing.

Aquifer depth may come from information gathered from drilling or public information maps or use of the County Well Index. Drilling is essential because it provides real physical information about the water table and soils in the particular area of interest. Drilling may also be of assistance in determining aquifer type as listed above. Designs may change based on the type of aquifer, for example, a perched groundwater table may not require the same design as one under artesian pressure. It can also help determine the thickness of the aquifer.

Hydraulic conductivity describes rate that water can move through a permeable material, the term may also be called **Coefficient of Permeability**. **Permeability** is an intrinsic property of the material and is affected by the grain size distribution, porosity, mineral constituents of the material, and how saturated the material is. The coefficient of permeability (**k**) for any material can be estimated in several different ways. Typical soil permeability values are given in the table below.

Table 6-1 Typical Soil Permeability Values

MnDOT Triangular Textural Classification	Coefficient of Permeability (ft/day)	Degree of Permeability
Gravel	10^2 - 10^5	High Permeability
Sand	10^0 - 10^2	Permeable
Loamy Sand	10^{-4} - 10^{-1}	Low Permeability
Sandy Loam	10^{-4} - 10^0	Low Permeability
Loam	10^{-4} - 10^{-3}	Impermeable to Low Permeability
Silt Loam	10^{-4} - 10^{-3}	Impermeable to Low Permeability
Sandy Clay Loam	10^{-4} - 10^{-2}	Impermeable to Low Permeability
Clay Loam	10^{-4} - 10^{-3}	Impermeable
Silty Clay Loam	10^{-4} - 10^{-3}	Impermeable
Sandy Clay	10^{-5} - 10^{-2}	Impermeable
Silty Clay	10^{-5} - 10^{-3}	Very Impermeable to Impermeable
Clay	10^{-7} - 10^{-5}	Very Impermeable

The following formula was adapted from the formula developed by Moulton (FHWA-TS-80-224) for permeability analysis on granular bases and sub base material.

$$\text{Where: } n = \text{porosity} = \left(1 - \frac{\gamma_d}{62.4 * G}\right)$$

$$k = \frac{6.214 * 10^5 \left(\frac{D_{10}}{25.4}\right)^{1.478} * n^{6.654}}{(P_{200})^{0.597}} \quad G = \text{Specific Gravity (assumed 2.7)}$$

$$\gamma_d = \text{Dry Density (lbs / ft}^3\text{)}$$

P_{200} = Percent passing No. 200 sieve (use percentage value ie. 2 for 2%)

D_{10} = Effective Grain Size (in inches)

This formula can also be used to estimate the soil permeability for soils where groundwater is expected to have an effect on construction.

Aquifer properties may also be calculated by performing tests on the aquifer or the soil. As discussed in Section 3.4, **slug tests** are utilized to determine aquifer properties. Several methods, depending on piezometer and aquifer dimensions, exist to calculate permeability. A method often utilized by the Geology Unit is the Hvorslev Slug-Test Method. Contact the Geology Unit with questions on which method to use.

On projects where construction dewatering will have a large-scale effect on the project, project costs, the aquifer, or surrounding buildings, **pump tests** may be employed. **Pump tests** are conducted by pumping a well for a period of time and noting the change in hydraulic head. They are much more costly to run than slug tests but can provide more accuracy in information. Contact the Geology Unit with questions on the types of testing appropriate for a project.

6.19.2 Engineering Hydrogeology

Hydrogeologic data are applicable to a variety of problems both directly and indirectly affecting the success of any construction project. Groundwater can affect the stability of structures or highways, the costs of construction, the costs of maintenance, and the effects of construction on adjacent properties, wetlands, and wells. It is important to predict adverse conditions so they can be mitigated in the design stages, and not come as a surprise during or after construction. Such predictions can be made only on the basis of adequate hydrogeologic information, and can be only as accurate as the data on which they are based. It is, therefore, essential to gather groundwater data as carefully, accurately, and thoroughly as possible.

The determination of groundwater conditions and the general hydrogeologic regime of a project site should be addressed during the initial investigative portions of the project. The location of the water table, including the presence of artesian conditions, or a perched water table are important items that must be determined by an exploration program; and careful consideration must be given to its potential impact on construction and long-term life of the project. Current Department design standards require that groundwater be kept at least five feet below the finished grade on roadway projects.

Consideration must also be given to groundwater conditions (whether true groundwater or perched water) behind retaining walls and bridge abutments, in backslopes, and springs from rock outcrop/cuts.

Care must be taken to prevent contamination of near-surface aquifers, especially when removing overlying confining layers or when penetrating the aquifers by soil borings or during construction. Construction in areas where groundwater may be encountered has the potential for impacting water wells, particularly down gradient from the project. In areas of the state where wells are particularly sensitive (such as the bedrock aquifers along the North Shore), or where wells are located within 200 feet of major construction, preconstruction inventories are often taken to document the existing condition of the wells. This data can then be used for comparison to post-construction conditions should claims occur.

6.19.3 Control

Groundwater control may be necessary when the water table exists within the frost zone of the roadway. To insure that groundwater does not adversely affect long-term performance of the roadway, the finished grade should be separated from the water table by a depth roughly similar to the depth of frost penetration. This depth is generally considered to range from four to seven feet across the state, and is generally considered to be 5 feet on average.

Every effort should be made to satisfy the grade-water criteria. If grades cannot be kept at least five feet above the water table, then special **groundwater control** designs will be required. Water levels will need to be lowered both temporarily during construction, and permanently for the life span of the pavement.

Temporary construction dewatering is the normally the responsibility of the contractor. It is important to provide a general assessment of the aquifer characteristics to potential contractors prior to the bidding process. The necessary elements that are important to a contractor, such as hydraulic conductivity, aquifer thickness, and gradation of aquifer materials, are generally necessary for design of the permanent groundwater control system.

Groundwater lowering can occasionally have unintended consequences and depending on the nature of the work and the size of the area, the project may require a thoughtful review and development of language for the project special provisions to minimize the potential of adverse effects. As an example, lowering the groundwater table over a large area impacts soil effective stress parameters and can increase the unit weight of soils which were previously saturated and are now wet or moist. As the material buoyant unit weight shifts to the wet unit weight the soil mass may now exert additional load on underlying soil deposits. If these deposits are weak or compressible, settlement may result from construction dewatering operations (refer to the section on permanent groundwater lowering below).

Permanent groundwater control is accomplished through the use of gravity drainage methods including longitudinal drains, blanket drains, or cut-off drains. In most cases such drains require project specific designs that relate to aquifer parameters such as soil type, hydraulic conductivity, depth of lowering required, thickness of the aquifer, and most importantly, a place to drain the captured water to. Permanent lowering of the water table should not be undertaken without consideration of possible **adverse impacts**, such as settlement of adjacent structures built on organic soils or loose sands, influence on nearby wells, increased construction expense, and longevity of design (and consequence of failure).

By request, the Geotechnical Section will analyze the hydrogeology of the project area in relation to the roadway design, and provide recommendations for controlling groundwater on the project. The Geotechnical Section currently recommends the use of passive drainage systems to lower the water table. Typically, project requirements and soil properties dictate the use of a specific system, or combination thereof. The two most common systems include the **Deep Drain System** and the **Blanket Drain System**.

The Deep Drain System consists of deep perforated drainage pipes spaced at distances to keep the groundwater at the appropriate level. These pipes usually parallel the roadway (Figure 6-5). This system is recommended for moderate to high permeability soils.

Figure 6-5: Deep Drain System, Adapted from FHWA, "Highway Subdrainage Design"

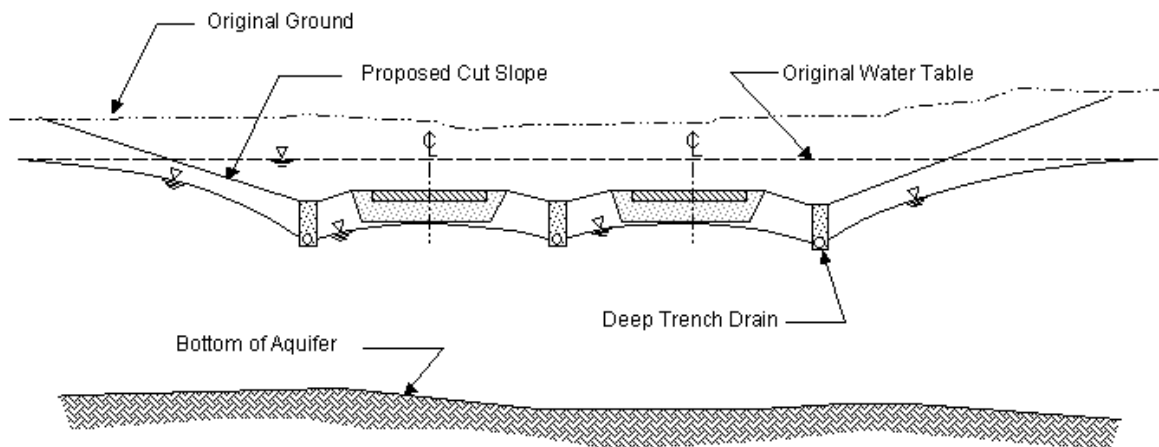

A second drainage system is the **Blanket Drain System**. Blanket drainage systems use an aggregate drainage layer between two geotextile layers. These layers act as filters keeping the fines from plugging the aggregate layer. The blanket is placed in the bottom of the subcut and parallels the finished grade. Water flows into the drainage pipes from the blanket and is then carried to a storm water system. Figure 6-6 shows

the standard blanket drainage system and the assumed groundwater flow. The pipes for the drainage blanket design should be properly sized to carry the amount of water desired for the entire length of the blanket.

Figure 6-6: Drainage Blanket System Adapted from FHWA, "Highway Subdrainage Design"

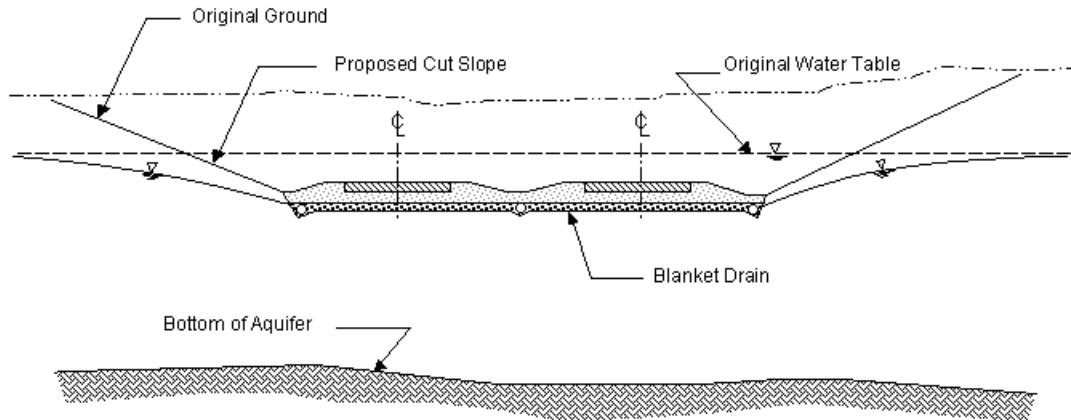

These two drainage systems may also be used together on a particular project. This is common on high profile projects where failure of one system could cause closure of a multilane highway and effect many people. The redundancy of two systems would lessen the chance of that occurring.

6.20 Geosynthetics

There are a large number of geosynthetic materials available on the market for use in geotechnical applications. These products generally fall into major categories of separators, reinforcing elements, impermeable barriers and liners, drainage elements, filters, paving fabrics, and composite systems where the material performs more than one function. Although many products may look similar, material characteristics can vary widely among materials. It is important to verify that materials delivered to a project site are consistent with design requirements. Materials must also be installed properly, in the correct direction, with correct connections (seaming, welding, overlapping, butting, etc..) per the project specifications to ensure that the design intent is met.

Certain products are more sensitive to UV degradation, installation damage, chemical attack, and other factors; for this reason it is imperative that the purposes of the geosynthetic be well identified as well as the environment where it will be installed well defined.

Geosynthetics, when incorporated as reinforcing or separation elements are part of an engineering design (as is rebar in concrete), are integral to the successful performance of the structure. Designs must not be field altered or changed without clearing those design changes with the engineer of record. To do so incurs liability and is poor engineering practice.

It is important that specified products be used where the design product is the exact product used in construction. Substitute materials, if allowed, must be carefully examined to make sure that all the physical parameters are consistent with the design engineering intent. Many materials may possess similar strengths, but not permeabilities; strengths may also vary widely in the cross-machine (perpendicular to the primary) direction. Failures have occurred because “apparently similar” materials were substituted on projects without first checking with the design engineers. These apparently harmless changes have caused significant cost overruns and project delays while also risking contractor and public safety.

MnDOT has approved products lists for materials depending on their use. In some cases, accepted design parameters for these materials must be used in design; these accepted parameters often include factors to account for creep, installation damage, or other factors. Check the appropriate standard plans and special provisions for additional details on how to present and use geosynthetic strength requirements in the project plans and special provisions. In general, certifications and/or compliance tests are required for geosynthetic materials used on MnDOT jobs.

6.21 Retaining Walls

Retaining walls can be constructed by a variety of methods; most commonly they are supported by shallow foundations, but are alternately constructed with deep foundations or as shallow foundations on replaced or improved ground.

MnDOT constructs retaining walls by a variety of techniques, most frequently including cast-in-place cantilever walls and mechanically stabilized earth walls with a variety of facing techniques. Standard plans are available for cast-in-place walls founded on soil or rock.

Reporting for retaining walls should be based on project needs, wall types, geotechnical site conditions, site layout and geometry, construction staging, and other pertinent considerations such as any nearby water features, and if “top down” construction may be a more practical alternative over traditional “bottom up” construction in certain design scenarios.

6.22 Noisewalls

Noise wall reports should include geotechnical information and appropriate analysis to ensure that the walls perform well and do not require excessive maintenance due to settlement or overturning. Noisewalls frequently use standard designs. As with other constructed works, if the soil investigation reveals that there are areas where the noisewalls may encounter problematic construction (artesian conditions, shallow rock, or peat) this should be highlighted in the geotechnical report and brought to the attention of design personnel such that a specialty design or guidance can be included in the plans.

6.23 High-Tension Cable Guardrail End Anchors

Geotechnical investigations are required for high tension cable guardrail installations to ensure that the soils present at the actual anchorage locations meet the minimum soil parameters assumed by the designers.

6.24 Lightweight Fill

Lightweight fills are useful in design scenarios where additional weight associated with additional embankment earth loading can cause instability or problematic (or undesirable) settlement or deformation. There are a variety of materials that can be used as lightweight fill for construction including:

- 1) Lightweight Aggregate (expanded shales and similar)
- 2) Expanded Polystyrene Geofom (EPS Geofom)
- 3) Wood Chips
- 4) Shredded Tires or Tire Chips
- 5) Cellular Concrete (also 'Foamed Concrete')

Each of the material types has certain advantages and disadvantages. Many types have restrictions on where they can be placed or certain design considerations related to buoyancy, encapsulation, location with respect to the water table, and other construction considerations.

6.25 Utilities

Refer to the LRFD policy on "Utilities Near Foundations" for information on when special designs and accommodations are required for utility construction or retrofitting. This policy provides guidance on both wet and dry utilities near shallow and deep foundations.

6.26 Infiltration Ponds Near Structures

Refer to the policy on placing infiltration ponds near structural walls and existing bridge foundations for information on general restrictions for lateral offsets of these facilities and conditions when specialty designs are required to ensure proper system performance.

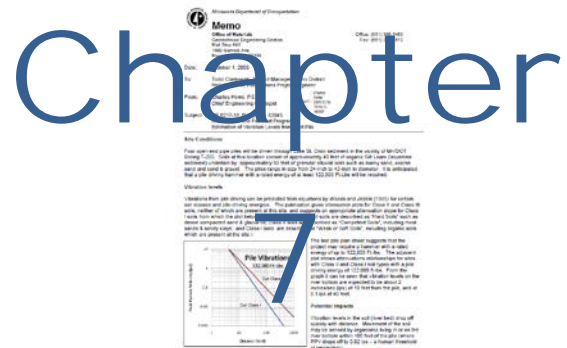

7 Geotechnical Report

The geotechnical engineer will use the subsurface investigation information along with any supplemental information to produce a Geotechnical Engineering Report for each structure or geotechnical feature on the project. The recommendations will include engineering analyses and design recommendations and should be brief, concise, definite and easily interpreted. The reports will meet prudent and applicable industry standards unless otherwise noted hereinafter. Frequently, this report is given the name “Foundation Investigation and Recommendations” report.

7.1 Types of Reports

For most MnDOT projects the geotechnical section issues “Foundation Investigation and Recommendations” reports to be used by the Bridge Office and District Design and Materials Engineers as part of the design process for bridges, culverts, embankments, slopes, and other works. Other types of reports could include Geotechnical Information Reports or Transmittals, which serve only to provide raw investigation information without analysis and Geotechnical Baseline Reports which may establish MnDOT’s interpretation of stratigraphy or conditions for use in plans and contract documents. In addition, specialty reports such as those generated from site reviews where a formal investigation may or may not have been conducted are also produced on a routine basis.

7.2 Report Content and Practice

Designs, calculations, and recommendations will be reviewed, checked, dated, and initialed by a registered professional engineer. All analysis work and calculations performed by the Geotechnical engineer will be in accordance with methods recognized as conforming-to good engineering practice. Methods and procedures for analyzing stability, settlement, bearing capacity and pile requirements will be at the discretion of the Geotechnical engineer, except that all assumptions, soil parameters, water levels and design criteria will be indicated. The method of analysis and procedures will be referenced to engineering texts, handbooks, and journals including page numbers. The

Geotechnical engineer will at his discretion use computer programs for performing computations and for analysis purposes insofar that such programs are available. If a computer program is used, the output forms with the specific title of the computer program may be submitted in lieu of design computations. A check calculation initialed by a Registered Engineer will be performed on the most critical slip circle when limit equilibrium slope stability computer analysis is used.

7.3 Presentation of Subsurface Investigation Information

The Geotechnical engineer will present the results of the subsurface investigation with each Geotechnical Report in the form of plotted borings on proposed plans and profiles and cross sections where applicable. The plotted borings may be abbreviated but must include soil and rock classifications, Standard Penetration Test values, unconfined compression test results and a water table symbol all plotted with depth. All plots will be generally be made on tabloid (11 in. by 17 in.) size paper and plotted to an engineering scale except where the project sites may be small and a smaller size is appropriate.

Information is to be conveyed such that boring location and stratigraphy is presented in a meaningful way. It is preferred that geotechnical information be presented relative to the proposed structures such that engineers can readily determine the locations of foundation elements and other features with respect to the borings, soundings, and geophysical studies.

7.4 Project Information

The Geotechnical Report will contain a separate section labeled "Project Information". This section will include an overview of information about the type of structure analyzed, the location of the structure and any other pertinent information (such as earlier structure numbers and any previous construction or maintenance problems or considerations) which aids in the general description of the design. This section may also include information on construction sequencing or background on design selection or functional requirements. This section may be supplemented with additional information or with other sections such as "Project Background" if the report is a part of a series of investigations, or if substantial previous work exists to help lend context to the content of the current report.

7.5 Subsurface Investigation Summary

The Geotechnical Report will contain a separate section labeled "Subsurface Investigation Summary". This section will include information about the geophysical investigations, borings, soundings, or other advances undertaken for the site, a brief description of the foundation soil and rock conditions at the site and a summary of the water table measurements taken and an interpretation of the static water level.

This section, or a similar section should contain address any relevant discoveries, such as highly variable sites, presence of cobbles and boulders, problematic rock deposits

(such as karst areas), compressible clay soils, organic materials, or unusual circumstances such as urban fill or any apparent soil contamination.

7.6 Geotechnical Analysis

The Geotechnical Report will contain a separate section labeled "Foundation Analysis". For this section, the Geotechnical engineer will summarize the results of a detailed geotechnical engineering analysis to identify critical design elements and provide a basis for geotechnical recommendations. At a minimum, the Geotechnical engineer will address the following:

- a) A summary of the design assumptions including but not limited to information about embankment fill heights, unit weights of fill, side slope and end slope angles, bridge loading information (both axial and horizontal), retaining wall loading information, design methodologies, and other pertinent information will be provided.
- b) For structures, suitable foundation types will be assessed and alternate foundation types reviewed.
- c) For embankments, the overall stability will be assessed including a bearing capacity analysis, settlement analysis and global stability analysis. If necessary, the Geotechnical engineer will provide a settlement analysis for the use of wick drains, surcharge embankments, and lightweight fill material. In addition, an estimate of the time rate of settlement will be included to account for the primary and secondary settlement that may be expected over the life of the project
- d) For spread footing foundations, a bearing capacity and settlement analysis will be provided. The analysis will include a summary of the allowable and ultimate bearing capacities and the assumed safety factors. The analysis will include an estimate of the total and differential settlements anticipated for each structure analyzed. Differential settlements for retaining walls will be calculated based on 30 foot spacing. In addition, an estimate of the time rate of settlement will be included to account for the primary and secondary settlement that may be expected over the life of the project. All spread footings will be designed for a minimum embedment depth of 4.5 feet to protect against frost heave effects.
- e) For piles and drilled shafts, ultimate capacity figures will be developed that show the capacity in relation to tip elevation for both compression and tension. In addition, downdrag and lateral squeeze will be reviewed. Lateral earth pressure calculations including parameters for P-y curve development for structures subject to horizontal loads will be developed. Minimum tip elevations, casing requirements and estimates of overdrive will be provided.
- f) All foundation elements will be designed to account for losses in lateral and axial capacities resulting from calculated design scour depths.

- g) Analyses for structures supported on rock or tied to rock formations will be addressed. This includes analyses for areas such as rock bolts and rock cuts.
- h) Construction considerations such as design of temporary slopes and shoring limits will be addressed. Special Provisions will be prepared for elements that may encounter difficult ground conditions or that may require non typical construction methods. Over excavation (subcuts) recommendations and backfill requirements will be discussed and details prepared for the project. Construction staging requirements, where applicable, will be addressed. Wet weather construction and temporary construction water control will be evaluated.

7.7 Foundation Recommendations

The Geotechnical Report will include a section labeled "Foundation Recommendations". This section will include definitive recommendations such as

- a) Ultimate and allowable bearing capacities and associated LRFD resistance (ϕ) factors
- b) Recommended footing sizes and embedment depths (or a chart indicating capacity available based on effective footing sizes)
- c) Recommended pile size and estimated lengths and tip elevations
- d) Recommended drilled shaft dimensions and construction methods
- e) Recommended slope angles for embankments
- f) Waiting periods for embankment construction
- g) Surcharge methods/system recommendations
- h) Recommended foundation types, sizes, and embedment depths
- i) Recommended rock cut slopes, including slope and subsurface drainage recommendations
- j) Top soil excavations and muck and poor soil removal/excavations
- k) Trench excavation slopes
- l) Temporary slopes and shoring limits (where appropriate)
- m) Rock excavation and any other recommendations as they apply to the design.

The recommendations are to be separated into two categories: General Recommendations and Special Recommendations. The General Recommendations contain common recommendations that are frequently repeated on projects, such as protecting foundations from frost and constructing embankments at a suitable slope angle to improve performance. The Special Recommendation section contains detailed information important to the particular project. The information in this section is often project critical and is based on a review of both the project site and design intent.

Chapter



8

8 Vibration Concerns/Management

8.1 Blasting

Rock blasting is the controlled use of explosives to excavate or remove rock. The decision of whether or not to use blasting on a project should be made early in the project planning phase. Some types of rock (such as shale, sandstone or thinly-bedded carbonates) that are encountered on a project may be excavatable by standard soil equipment. Other rock types may require more energy intensive techniques such as ripping, or for small areas, percussive hammering. The Geotechnical Section may be contacted for assistance in determining if the rock needs to be excavated by blasting, and to what extent the rock will be encountered on the project.

Construction of roadways and structures often requires the removal of rock by the use of one or both of the following blasting methods; **Production Blasting**, which refers to the main fragmentation blasting resulting from the appropriately spaced production holes drilled throughout the rock excavation area, and **Controlled Blasting**, which refers to the controlled use of explosives and blasting accessories in carefully spaced and aligned drill holes to produce a finished surface or shear plane in the rock along the specified backslope.

8.1.1 Production Blasting

If the other method is called “controlled” blasting, is this method “uncontrolled”? In some ways, the answer is yes and some ways no. Production blasting is used for the bulk removal of rock within the project area. It is uncontrolled in that there is no real effort to shape a final rock slope. It is controlled in that the blaster must design appropriate patterns to make excavation of the blasted rock easy for the contractor, while using the minimum amount of explosives and drilling time. Additional controls may be set by the State that limit vibration levels, or that require reduced loading as the excavation approaches a cut face that will require controlled blasting. MnDOT

specification 2105.3C requires presplitting (controlled blasting) for all final rock back slopes steeper than 1V:1H. Occasionally, production blasting is misguidedly used for aesthetic purposes to eliminate the drill hole traces (half casts) on a final cut face, resulting in overbreak of the rock beyond the planned cut face and a resultant unstable cut face.

Figure 8-1: Production blasting showing movement (bulking up) of the rock



8.1.2 Controlled Blasting

This method is used for shaping a final cut slope, where overbreak of the rock beyond the final face is undesirable. Rock excavation for highway construction often requires the formation of cut faces that will be stable for many years, and will also be as steep as possible to minimize excavation volume and required right-of-way. While these two requirements are somewhat contradictory, the stability of rock cuts will be enhanced, and the maximum safe slope angle increased by the use of a blasting method that does the least possible damage to the rock behind the final face. Methods of minimizing blasting damage are included in the general term “controlled blasting.”

Figure 8-2 Rock face blasted with controlled blasting

There are several different controlled blasting techniques that include line drilling, cushion (or trim) blasting, presplitting, and smooth-wall blasting. These procedures are typically used by MnDOT when a final cut slope is higher than 6 feet and steeper than 1V:1H (see Rock Slope Design). Equally important is its use when no final rock slope faces will be exposed, but structures such as abutments or footings are founded on the rock above the cut slope.

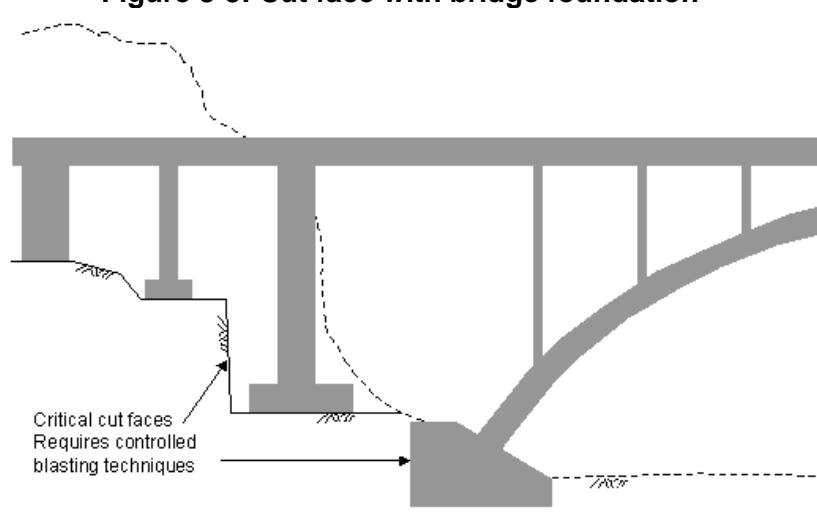
Figure 8-3: Cut face with bridge foundation

8.1.3 Blasting Specifications

When blasting is specified on a project, appropriate sections of the Blasting Special Provisions SP2005-74 through SP2005-76 should be incorporated into the project bidding documents. Current special provision language for blasting can be found at <http://www.dot.state.mn.us/pre-letting/prov/pdf/sp2005.pdf>. The special provisions cover general blasting requirements such as:

- Use of explosives
- Blasting plan requirements
- Shot log
- Scaling and stabilization
- Safety
- Flyrock control
- Vibration control and monitoring
- Rock excavation by production blasting
- Rock excavation by controlled blasting
- Measurement and payment

Note: MnDOT Specification 2105.3C requires presplitting for all rock backslopes steeper than 1:1 in hard rock types such as igneous, metamorphic, and carbonates. If some other controlled blasting method, such as cushion blasting, or non-controlled method is desired, it should be specified in the Special Provisions for the project.

8.2 Vibrations

Both beneficial and detrimental to transportation construction, vibrations compact soil, drive piles into the ground and break-up old concrete pavements. Detrimental effects may include damage to structures, settlement of loosely consolidated soils, interference with sensitive equipment and operations, or disturbance of nearby building occupants. This document covers a brief summary of construction vibration monitoring and control; see the Geology Unit website for an in depth look at construction vibration concerns and measurement. Transportation related construction activities produce and experience both airborne and earthborne vibrations.

8.2.1 Airborne Vibrations

Blasting and operation of heavy construction equipment cause air pressure waves described as air blasts as well as construction noise. These pressure waves can be shown with time histories, where the amplitude is the air pressure fluctuation from the atmospheric pressure. The higher-frequency (20 to 20,000 Hz) portion of the air pressure wave is audible and is described as sound or **noise**. The term noise generally indicates that the sound is “unwanted”. This type of disturbance is usually not damaging to structures, but is often annoying to humans. The “noise” component of sound is well regulated by Federal Agencies, and at MnDOT, it is measured and assessed by the Noise Analysis Section:

<http://www.dot.state.mn.us/environment/noise/index.html>

The low-frequency portion, mostly inaudible, excites structures causing them to vibrate similarly to the response of ground vibrations. Rarely high enough to produce damage, these vibrations often cause windows and walls to rattle, leading occupants to believe that their residence is being damaged. It is difficult for the occupant to differentiate between rattling caused by ground vibrations or by low-frequency sound. The Geology Unit conducts tests to assist in making this distinction, which may be necessary to design appropriate mitigation.

In noise studies, sound pressures are measured with acoustic sound level meters that are “weighted” to measure the higher-frequency sounds that annoy humans. These instruments typically employ an A- or C-weighting scale, which do not adequately respond to the low-frequency pressure pulses (1 to 30 Hz) that excite structures. For proper measurement of the lower frequency portion of construction pressure pulses, a linear or **L-weighted** scale should be used.

8.2.2 Earthborne Vibrations

Earthborne vibrations are described as the motion of a ground particle, at a point in or on the ground, as vibration energy passes through that measuring point. The actual distance that the ground particle moves, either positively or negatively, from its at rest position is **displacement**. Displacements from construction (including blasting) are very small and are reported in units of inches or mils (thousandth of an inch). The other two frequently used ground motion descriptors are velocity and acceleration. Particle **velocity** is the speed at which a ground particle oscillates (this should not be confused with the velocity with which the wave travels through the ground, which is propagation velocity) and is reported in units of inches/second (ips). **Acceleration** is the rate of change of velocity with time and is reported in units of inches/second/second (in/sec²). Acceleration is often normalized with (divided by) the gravitational acceleration on the earth’s surface (386.4 in/sec²) and reported in g's as a percent of gravity.

Construction generated ground motion is divided into three main wave types: **compressive (P)**, **shear (S)** and **surface (R)**. To describe the motion of the ground as earthborne vibrations pass through it, three mutually perpendicular components must be measured. A triaxial **geophone** has three independent transducers, each aligned at mutually perpendicular directions. By convention, the **longitudinal** direction is aligned with the axis of the vibration propagation and the **transverse** direction at a right angle to that, in the horizontal plane. The **vertical** direction measures movement in the vertical plane, which often has the highest amplitude.

8.2.3 Vibration Sources

Many types of events create vibrations including natural processes such as earthquakes, wind and volcanoes. Vibrations created by human activity are much lower than these natural sources and can be conveniently grouped into three categories; 1) Blasting, 2) Construction Equipment, and 3) Transportation. **Blasting** typically generates the highest vibration levels, and causes concern at distances up to a few hundred feet (farther than that for large mining/quarry blasts). **Construction** equipment such as pile driving, dynamic compaction, pavement breaking, and vibratory compaction usually produce lower vibrations than blasting but still cause problems when they are within 200 feet of a sensitive receiver. These first two categories of vibration sources typically generate **discrete** or **transient** vibrations, and each vibration event is analyzed for damage potential by its amplitude and frequency. **Transportation** related sources; including trains, heavy truck traffic, and traffic in general, typically produce even lower

vibrations, but can also cause potential problems when they are within 100 feet of the receiver, because they are often **repetitive**. Repetitive or **continuous** vibrations can cause damage at lower levels than transient vibrations due to fatigue failure of the structure. As shown in following sections, transient and continuous vibrations affect humans and structures differently and require unique damage criteria.

8.2.4 Vibration Receivers

Vibrations adversely impact three primary types of receivers: **structures**, **people**, and **equipment**. Of these three types, structures typically take the highest vibration levels without being impacted. Adverse impacts to structures are normally described as **damage**, whereas impacts to humans can be described as **annoyance** or disturbance. Impacts to equipment are usually in terms of hindering or reducing its functionality.

Structures

Damage is a very imprecise term. It describes the opening of hairline cracks in sheetrock walls as well as collapsing of a structure. The blasting industry defines damage more precisely (below) using these terms to describe all construction vibration-induced cracking damage:

Construction-Induced Cracking (Dowding, 1996)

Cosmetic cracking including threshold damage: *opening of old cracks, and formation of new plaster cracks; dislodging of loose structural particles such as loose bricks in chimneys.*

Architectural or minor damage: *superficial, not affecting the strength of the building (e.g. broken windows, loosened or fallen plaster), hairline cracks in masonry.*

Structural cracking or major damage *results in serious weakening of the building (e.g. large cracks or shifting of foundations or bearing walls, major settlement resulting in distortion or weakening of the structure, walls out of plumb).*

Project vibration limits are usually designed to prevent threshold or cosmetic cracking. “These levels produce strains/displacements at/or below those necessary to cause cracks that normally appear in a home as the result of the natural aging process as well as normal weather-induced expansion and contraction” (Dowding).

People

Vibrations impact people in two different ways; they can either annoy, or they cause perception of damage. They can be annoying in that the actual vibration can be felt, or they can cause a rattling of items within the building. Humans are able to sense vibrations at levels far below those necessary to cause damage. When people feel a vibration or hear the rattling of objects in their house they immediately think of damage and start looking for evidence. Often, people discover cracks in walls, ceilings, or

foundation blocks that they hadn't noticed before, and now associate with that vibration event.

Equipment/Operations

Vibrations also adversely impact sensitive equipment and/or operations, such as hospitals, computerized industries, research centers or industrial machinery. Some equipment can be more sensitive than humans since their operation can be impaired before the vibration levels reach the threshold of perception. However, most of these instruments and/or operations must be isolated within their own buildings to prevent normal building activity from disturbing them. For this reason, construction related activities rarely impact highly sensitive equipment/operations.

8.2.5 Vibration Impacts (When to be concerned)

Figure 8-4, below shows a graphical representation, developed from the research and experience of the Geology Unit, of relative intensities of construction vibrations and plots of the distance at which vibration levels are expected to drop below 0.1 ips. It is widely accepted that cosmetic damage cannot be attributed to construction vibration levels below 0.5 ips. However, 0.1 ips is used here because occupants of buildings typically complain about vibration levels down to 0.1 ips.

Figure 8-4: Distance at which vibration level drops below 0.1 inch/sec. for various Construction Related Activities.

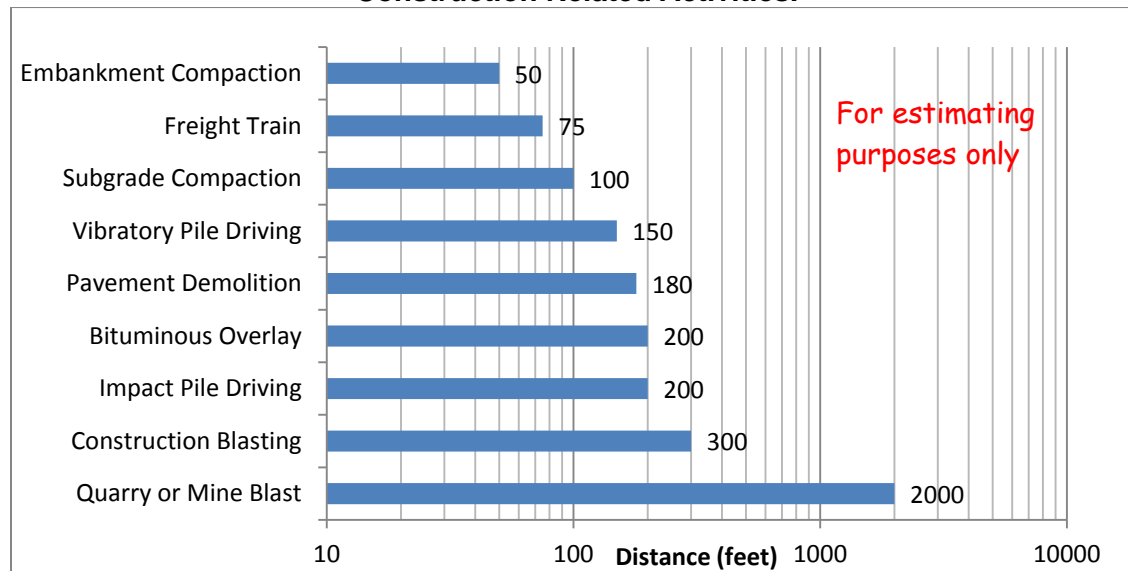

Blasting and pile driving create vibrations in the ground that occasionally cause damage to structures and disturb people nearby. Other construction activities, such as pavement breaking, vibratory compaction, and the general use of heavy hauling and excavating equipment, produce vibrations that are below the level that would be considered damaging, unless they are very close (<25 ft). However, these lower intensity vibrations

can certainly be annoying, and may cause occupants to believe that their buildings are being damaged. Certain other uncommon conditions such as proximity to historical buildings or buildings with historical or antique artifacts may require special consideration.

Human perception of vibration is not an accurate gauge of the damage potential of a vibration. Consequently, when assessing the potential for impacts due to construction vibrations, it is necessary to consider both: 1) the actual potential to cause damage; and 2) the potential for causing complaints about being damaged.

Vibrations do not affect all structures similarly. Some factors that may affect a structures ability to withstand vibrations are: condition, type of construction, geometry, and orientation.

Condition - Structures are typically strongest just after completion of construction. Through the years they receive many cycles of stress and strain due to changes in temperature and humidity, ongoing vibration events, and settlement of soils on which they are founded. Structures where damage has already occurred are more susceptible to additional damage from an external vibration event. It is easy to imagine that a building with loose bricks on the exterior would shed those bricks at much lower vibration levels than a building where all the brickwork is sound. Historic structures are often in poorer conditions than modern structures because of their longevity and inferior building products. At any rate, they are often given a lower vibration limit because repair materials may no longer be available, and any permanent losses would not be tolerable to the public. Existing conditions should always be assessed for structures within a given radius of blasting or pile driving operations. That distance can be established based on prior experience, calculations based on damage probability and predicted vibration levels, political concerns, or a combination of all three.

Type of Construction - Engineered structures are normally constructed of stronger, more durable materials, and are often founded on piling or on some type of engineered soil. Structures made of concrete and/or steel are not subject to the desiccation that occurs in wood-framed structures. Engineered structures are often more rigid and have sufficient support.

8.2.6 Damage Criteria

Many different criteria exist for vibration levels to limit the possibility of damage to surrounding structures. Two of these criteria are noteworthy and have been used on past MnDOT projects. The first criteria comes from the California Department of Transportation (CALTRANS) document, "Transportation- and Construction-Induced Vibration Manual" (Jones & Stokes, 2004). This document provides criteria for both transient and continuous vibrations (Table 8-1) as well as annoyance criteria (Table 8-2).

Table 8-1: Guideline Vibration Damage Potential Threshold Criteria (After Jones & Stokes, 2004)

Structure and Condition	Maximum PPV (in/sec)	
	Transient Sources	Continuous/Frequent Intermittent Sources
Extremely fragile historic buildings, ruins, ancient monuments	0.12	0.08
Fragile Buildings	0.2	0.1
Historic and some old buildings	0.5	0.25
Older residential structures	0.5	0.3
New residential structures	1.0	0.5
Modern industrial/commercial buildings	2.0	0.5

Table 8-2: Guideline Vibration Annoyance Potential Criteria (After Jones & Stokes, 2004)

Human Response	Maximum PPV (in/sec)	
	Transient Sources	Continuous/Frequent Intermittent Sources
Barely perceptible	0.04	0.01
Distinctly perceptible	0.25	0.04
Strongly perceptible	0.9	0.10
Severe	2.0	0.40

The second criteria comes from studies by the U.S. Bureau of Mines, which established limits for residential structures based on blasting experience. In their studies it was determined that frequency plays an important role in vibration damage, allowing higher limits to be set for higher frequency vibration events. The Office of Surface Mining modified the Bureau of Mines proposed criteria and developed the widely used, "OSM Alternative Blasting Level Criteria (Figure 8.5) which is often specified in MnDOT contracts when no other vibration criteria has been established. Ideally, each project should be analyzed for the level of vibrations that will be produced, proximity and conditions of adjacent structures, and then establish vibration limits to avoid potential damage.

Figure 8-5: OSM Alternative Blasting Criteria
 (*These slopes represent a constant peak displacement in inches)

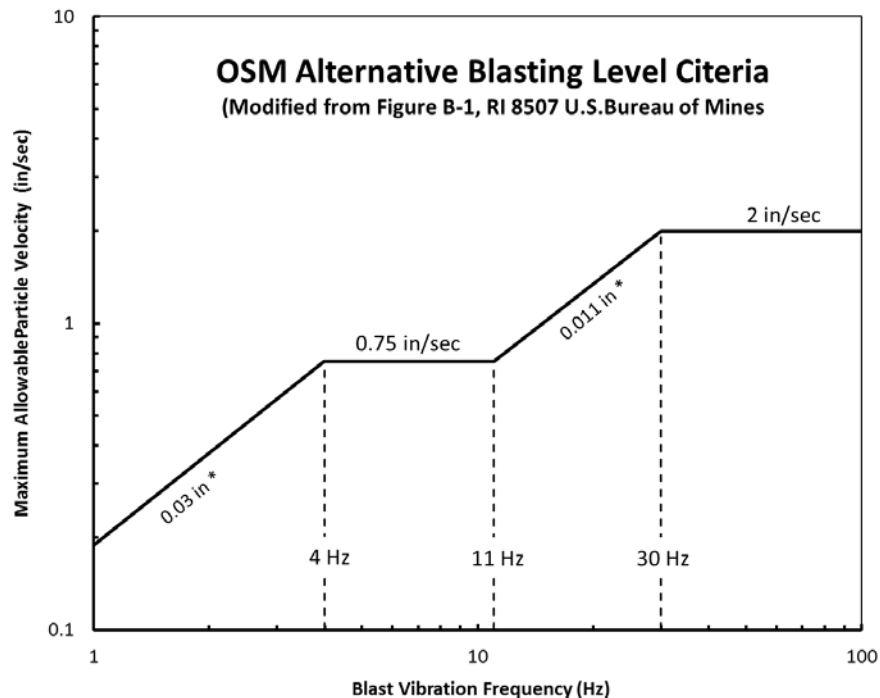

8.2.7 Monitoring Equipment

Vibration monitoring equipment generally monitors displacement, velocity, or acceleration over time. Vibrations are typically measured by transducers that change the ground motion into an electric signal. Velocity is measured by geophones that can measure the velocity in one (uniaxial) or three (triaxial) directions. Velocity is the most commonly used measurement for construction vibration monitoring. It is important to use properly calibrated instruments and geophones. Vibration may also be measured by accelerometers to measure acceleration. Strain gauges are used in monitoring structures in those areas where cracking is likely to occur.

8.2.8 Vibration Studies

Vibration studies for construction projects are normally conducted by a consultant working directly for MnDOT or a consultant that is retained by the contractor as required by contract special provisions. With some variation in the specific steps and level of investigation, the vibration study generally follows this outline:

- Identify anticipated vibration producing activities and proximity to potentially impacted receptors (structures, people and equipment).
- Perform a vibration susceptibility study to assess potential for impacts to receptors.

- Develop site specific vibration criteria to avoid threshold damage to structures and interference with sensitive operations.
- Identify structures that will require a pre-construction condition survey. This is often based on the distance from the vibration source where predicted vibration levels will fall below 0.1 ips.
- Conduct precondition survey to document existing conditions and damage.
- Monitor construction-related vibrations at critical receptors that were identified in the susceptibility study. The consultant typically has the power to stop construction activities if the vibration criteria are exceeded, and modification of the process is required before the activity may resume.
- Conduct post-construction survey at any receptor that has claimed damage from a vibration producing activity. This survey could actually be performed during or after construction.

Vibrations complaints also come from areas where there is no current construction project. Most often these complaints come from traffic noise or vibrations. These types of complaints can be investigated by the [Geology Unit](#) and are often resolved by identifying the reason for the high vibrations (bad pavement, lack of noise walls), or demonstrating that the vibration levels are not damaging to the structure.

8.2.9 Measurement

Vibrations shall be monitored with approved seismographs at the most critical sites. The seismographs should be capable of recording frequency and peak particle velocity in three mutually perpendicular axes. The seismographs shall also be currently calibrated and be able to record a peak reading over a period of time or histogram of vibrations as well as time histories of individual vibration events.

8.2.10 Addressing Vibration Concerns

At MnDOT, four levels of vibration control can be provided on a project, depending on things such as structure susceptibility to damage, proximity to vibration producing activities, local concerns, or district policy. A detailed procedure is included on the Geotechnical Section website. The "levels" can briefly be defined as follows:

Level 1 - No specific mention in contract of possible problems or controls. On a statewide basis, this is most common for minor or small quantities of pavement breaking or pile driving, when they are not in proximity to occupied structures or sensitive receptors.

Level 2 - Alert contractor to possible problems by brief description in the special provisions. Vibration levels and monitoring are at the discretion of the contractor, and the contractor is responsible for all damage caused by his activities.

Level 3 - Detail concerns and require the contractor to do a prescribed condition survey and to employ a qualified vibration specialist to establish a safe vibration level and monitor the vibrations. As an alternative, a vibration level may be set by the

Department, such as the "OSM Alternative Blasting Level Criteria". It may also be appropriate to use experienced based vibration criteria, such as established District 1 during construction of the Duluth Freeway Tunnels. The contractor is still responsible for all damage caused by his activities.

Level 4 - MnDOT takes lead role and has consultant(s) do a damage susceptibility study to establish vibration control limits, and a preconstruction condition survey for each structure. MnDOT also takes responsibility for vibration monitoring during construction to insure compliance with vibration control limits. At this level, the State assumes some responsibility for damage to structures if the established vibration limits are not exceeded by the contractor. The degree of responsibility depends on the vibration specification - most vibration specifications are aimed at avoiding structural damage, leaving the contractor responsible for any cosmetic damage (e.g. plaster cracks, broken windows, etc.) and keeping residents/occupants informed and "happy".

When projects call for control at Level 4 the following or similar steps are valuable.

- Determine the areas of concern near the project site.
- Perform a precondition survey of all structures (buildings, wells, historic sites) in the areas of concern that have potential for damage from vibrations.
- Notify the public about the project and about the possibility of vibrations.
- Determine work schedule and construction activities to minimize effects of vibrations.
- Inform nearby residents when vibration activity is to occur.
- Monitor vibrations.

Level 4 (Alternate) – This would be similar to level 4 except that MnDOT would direct the contractor to perform all of the activities identified above through contract language. The contractor would be required to select a consultant to perform a susceptibility study, set appropriate vibration limits, conduct a pre-condition survey, and monitor vibration levels. In this scenario, the contractor would be responsible for all damage caused by his activities.



Chapter 9

9 Instrumentation and Monitoring

Geophysical methods, borings, soundings, and other investigative tools are often considered the primary components of a geotechnical investigation. There are some sites however, where critical project parameters (i.e. strength, deformation, groundwater location or flow) change with time. At these sites, it is imperative not only to get information with respect to the location and type of geomaterials encountered and their physical properties at the time of investigation, but also to assess how conditions change over time.

As examples, it may be of interest to monitor groundwater at a future project site for several years prior to the construction program to determine if special dewatering measures are required for construction or for the permanent roadway project. It may also be of interest to assess how an unstable slope is moving, and at what rate, to better devise a remediation program. In addition to assessing how project sites behave geotechnically over time, instrumentation and monitoring can be used to log and record contractor activities or assess long term geotechnical and structural performance of constructed works. Occasionally, the State partners with universities and government agencies to conduct research on new designs, installation techniques, or construction materials.

9.1.1 In Situ Instrumentation and Monitoring

Project sites can be outfitted with geotechnical instrumentation and monitored at any point in the design, construction and service life of a structure or facility. Site conditions can be assessed prior to construction, during construction, following construction, or at such a time as there is an external circumstance that causes a need for a monitoring program. These circumstances could be natural erosion, a storm or landslide, or a construction activity that has changed the site geometry or groundwater character.

Placing instrumentation at a site and adopting a monitoring program helps document behavior; this information can then be used when developing a geotechnical design for

a project, adjusting and existing design, adjusting or responding to contractor activities, or improving future designs. In some cases instrumentation and monitoring is recommended for a project to support research, development, or implementation of construction techniques or processes.

On complex projects, the added time and expense of installing instrumentation is often beneficial to both contractors and owners. Civil engineering is slowly moving to a culture of more testing and performance monitoring following behind most other disciplines of engineering such as electrical and mechanical. The latest MAP-21 Federal Transportation funding program specifically includes language related to transportation asset management and infrastructure monitoring.

While not every project may immediately benefit from instrumentation and monitoring, those projects where the design may be innovative or “pushing the envelope” should include a thoughtfully designed program with the intent of measuring field performance to compare the predicted behavior with the observed behavior.

The design and construction of shallow foundation systems in particular stand to receive substantial benefit from monitoring programs and field evaluation; designs for shallow foundations are frequently conservative (when they are founded on “good” soils) and models often do not reflect the scale effects and construction method influences of full size foundations.

Certain types of projects require quality monitoring. Examples include:

- 1) settlement mitigation pre-loading and surcharging
- 2) groundwater elevation studies
- 3) landslide rate and magnitude monitoring (including rock movements)
- 4) load testing
- 5) structural [and geotechnical] health monitoring

Monitoring allows confirmation of predicted design behavior and can provide valuable information if there are deviations from expected performance. Showing that a design is functioning as expected is often an underappreciated outcome. The information can be beneficial as a validation of current design practice if the monitored parameters agree with expectations. If conditions are unusual, this can often lead to additional insights that are useful if performance is poor enough to require a mitigation program.

9.1.2 Pre-Construction (Investigation into Time/Rate Behavior)

Prior to certain projects, it may be necessary or beneficial to assess a site for stability or conditions which could be problematic during construction, such as high groundwater elevations. An investigation, instrumentation, and monitoring program should be designed and developed to answer specific questions based on the project needs. The size and extent of the monitoring program should be based on factors such as risk, cost,

benefit, the amount of known site information and the strength and redundancy of the transportation works being installed.

Engineering judgment is required; in general the cost of supplemental investigations and monitoring is small compared to the derived project benefits of risk reduction and improved confidence. Additionally, if the pre-construction instrumentation is able to be left in place during construction, the equipment may serve a useful purpose in addressing construction impacts.

9.1.3 During Construction (Quality Control / Quality Assurance)

Instrumentation installed during construction can be useful in assessing field performance, particularly if the site stratigraphy or material properties were not well defined, or if there was a large amount of uncertainty in the geotechnical design, or if the construction project involves major changes to the site environment (such as by excavation or pumping).

The most common geotechnical monitoring used during construction involves:

- 1) Noise and vibration monitoring
- 2) Settlement monitoring
- 3) Groundwater elevation and water flow monitoring
- 4) Static load testing for construction control

Certain construction techniques lend themselves to monitoring during production/installation, including pile driving, drilled shaft and auger cast pile installation, and the execution of many ground improvement techniques where equipment is monitored and displayed in real time.

If pile driving operations or blasting are used on a project, there may be monitoring requirements related to noise and vibration.

Frequently, temporary and permanent embankments, soil preloads, and soil surcharge operations are monitored to ensure the system is performing as intended. In the case of soil preloads and surcharges, the monitoring is usually used to determine both the magnitude and the time rate behavior of the work. It is important that monitoring begin as early as possible during excavation and loading operations so that as much of the embankment settlement (and any rebound) is captured as part of the monitoring program. Monitoring programs that start late in the construction sequence must have a rational technical reason for starting later. While 'settlement plates' are a traditional method of monitoring settlement, there are new techniques which allow precision settlement monitoring; these are described later.

Determining the actual settlement of shallow foundations is also of interest. Due to scale effects and construction methods, predicted and measured settlement of large foundations often disagree. Collection of full scale field data is useful both for the design

project at hand and for use in larger studies of shallow foundation performance. Because foundation movements are generally small (often less than 0.5 inches), systems with relatively high precision and accuracy are required.

Depending on the criticality of the work, it may be recommended that temporary sheeting and shoring be outfitted with survey targets or tiltmeters to ensure that lateral tolerances are not exceeded.

If local dewatering is used, it may be necessary to monitor impacts to nearby properties or important nearby water bodies such as streams and lakes.

9.1.4 Post-Construction (Performance Monitoring)

Periodically, after construction of geotechnical and structural works, it is of interest to monitor the performance of the constructed project or surrounding soils. In most cases this is because the structure's performance is of interest for research purposes.

There are cases where instrumentation is installed to help identify if there are performance impacts arising from a construction problem; at other times the construction process may reveal a feature or condition that is significant enough to be of interest, but not so critical as to require immediate action or a change to the construction program.

More often, post-construction performance monitoring is used to assess the behavior of constructed works for design validation or as part of research projects. In some cases, a monitoring program which is started in the construction phase may continue in-service following construction.

These programs have several benefits including the ability to capture construction impacts and the ability to install sensors as part of the construction project rather than as costly post-construction retrofits. This type of monitoring is not specifically intended to monitor contractor operations or evaluate the safety or effectiveness of the work in terms of contractor responsibilities during the project.

The most common types of geotechnical performance monitoring at MnDOT are related to evaluating the stresses and strains present in driven piles and the settlement behavior of roadway embankments, bridge abutment embankments, and shallow foundations.

9.1.5 Types of Instruments Used to Monitor Geotechnical Performance

There are a large variety of techniques to measure geotechnical parameters of interest for construction projects. Some methods require time and effort to read sensors in-situ, while other systems are fully automated.

Typical parameters may include:

- Stress
- Strain
- Water Pressure
- Water Elevation
- Vertical and Horizontal (Lateral) Earth Pressure
- Load
- Crack Opening or Closure, Alignment, Elongation
- Tilt, Rotation, or Angular Distortion
- Settlement
- X, Y, Z Location, Movement, Deformation

In addition, other parameters can be of some interest for projects including: Temperature, Barometric Pressure, and other Weather properties such as rain gages and solar radiation monitoring.

Sensors may be manual or automated; many are electronic, some are pneumatic or hydraulic. Electronic sensors come in a variety of types including electrical resistance, vibrating wire, potentiometers, fiber optic, and others. Most electronic sensors have power and data cables attached to them which must be considered in the design of an instrumentation program.

9.1.6 Settlement Plates

Settlement Plates are a simple, traditional device used to monitor settlement of embankments or earth fills. The apparatus is a flat plate (usually of plywood or metal) which has a fitting at the center of the plate for a riser pipe. Usually the central pipe is metal and has threaded connectors such that extensions can be added to the riser as fill is placed over the plate. To help protect the pipe from bending distress or distortion caused by the addition of soil fill a PVC plastic sleeve is used as a casing; this casing is extended up similarly to the riser extensions.

Settlement plates are installed at the base of excavations or at the base of new fills (in situations without a subcut or excavation). The elevation of the top of the riser pipe is measured by conventional surveying techniques. A fixed reference datum must be used such that measured changes in elevation, which can sometimes be very small, are reliably recorded. If new riser pipes are added, a survey should be conducted prior to adding the new pipe section and after. The length of the added pipe must be noted in the survey documents.

Settlement plates themselves are buried and abandoned in-place after the monitoring program ends. The plates provide information on the magnitudes of settlement and the progress of settlement can usually be inferred from the shape of the curve of elevation vs. time. Data should be recorded in tables or spreadsheets and be immediately plotted on a curve; this practice helps in the discovery of anomalous and potentially erroneous

data points. In the event of an anomalous point the survey data must be checked and if the cause of the error cannot be determined the plate(s) should be measured again.

Appendix G contains additional information on settlement plates, newer sensors for measuring settlement, sample data sets, as well as common errors.

As settlement information is important for determining consolidation progress and poor data can adversely impact the interpretation of the data, it is imperative that measurements be taken and reported with care. Additionally, it is important to protect settlement plates from disturbance and distress (such as bending).

Settlement plates must be installed as early as possible in the construction sequence, such that they capture as much of the anticipated movement as possible (for comparison with design predictions/estimates) and aid in describing the time rate of settlement.

Settlement plates must be surveyed to a minimum precision of 1/100 of a foot; conventional hand-held GPS systems are not precise enough to use for settlement plate measurements.

9.1.7 Settlement Systems

There are several hydraulic Settlement Systems available for use in characterizing settlement. MnDOT experience shows these systems to be exceptionally sensitive to installation care, temperature, and system de-airing.

A benefit of settlement systems is that they can be installed below embankment fills and therefore be less invasive to the construction process as there are no vertical rods protruding through fills (which impede contractor operations and lend themselves to damage or destruction).

A drawback of the systems is that they have fluid and electronic components which make the systems more complex and prone to error and external effects such as changes in air pressure, fluid pressure, and temperature.

Borehole settlement systems, where a borehole is drilled vertically to provide a fixed datum at a depth below compressible strata have been used successfully, although there is frequently a large amount of signal noise which needs to be accounted for in interpreting the data.

Differential-type settlement systems where sensors embedded within an embankment and referenced to a base station at roughly the same elevation outside the embankment are generally prohibited from use by MnDOT due to their history of erratic and arguably questionable data quality. These sensors are only permitted as part of a comprehensive, actively monitored system, with reference gages, and redundant instrumentation. There are some high-quality settlement systems available for use in tunneling and other applications which may be appropriate for use in environments

where temperatures are stable and the measurement systems are not prone to excessive installation or construction distress.

9.1.8 Horizontal Inclinometers, In-situ Inclinometers, and ShapeAccelArrays

Embankment settlement and vertical deformation may be assessed using traversing-probe inclinometers, in-situ inclinometers, or ShapeAccelArrays (SAA) placed horizontally across areas of interest. These systems use a linear casing and extend from a fixed (or geo-referenced datum) to a location within or beyond the area where settlement is to be measured.

Typically, horizontal installations are placed on the ground and covered with a protective 'hump' of soil before additional fill material is placed above the systems. Alternately a small trench may be dug to place the system slightly below grade. The casing for these systems ranges from about 1 to 3 inches; the trenches are often created with backhoes or other relatively large pieces of construction equipment and are generally larger width-wise than they would need to be. For this reason, some amount of soil cover over the casing is still usually required for protection, even if it is placed in a trench.

Historically, horizontal inclinometers consisted of a traversing probe, a data cable, and a data readout or recording device. If the installation completely spanned an area of interest with access on both ends, the probe was typically pulled from one end to the other with a cable (the cable is placed in the conduit and allowed to remain in the conduit for subsequent readings). For a system with a "dead end," a pulley system is installed at one end. A cable is used to pull the probe in to the end and the data cable is then used to retrieve the probe. The basic operation consists pulling the probe through the conduit which has a slotted casing (a slot at each 90 degree location around the circumference). The probe is paused intervals (usually 2 feet) as it is pulled across the study area (usually below an embankment) through the casing. Marks on the cable helped locate the intervals. When the probe reaches the end, the final set of readings for that run is recorded, the probe is then removed, rotated 180 degrees and returned to the starting point for a second set of readings. By reversing the probe, there would be improved accuracy by compensating for any systematic drift errors. The readings are compared in the data recording, processing, and presentation software.

This technique has many benefits- principally that the borehole casing is relatively inexpensive and the probe and related system can be used among many boreholes. The probe for horizontal installations is similar (somewhat larger) than that used for vertical inclinometer boreholes. Data on the inclination of the casing (and the surrounding soil obtained frequently along the length, creating a linear profile of settlement from an initial condition.

An initial survey must be conducted as future surveys will be compared to this initial condition. Both incremental deformations (from one reading to the next) and cumulative deformations (additive along the length) are computed based on the tilt of the sensor relative to gravity.

A drawback to the system is that it requires some skill to operate in the field to produce repeatable and reliable results. It is important that the probe be located properly and uniformly at each interval and on all surveys as the distance between probe movements is used as a length in calculating the displacements (along with the tilt of the probe). The operator should reuse the same probe for each data collection site, and trips to the site are required each time a dataset is required.

The deformation to be measured has to be relatively smooth across the installation length as these sensors are not designed for very large deformations across small lengths. SAA systems have been shown to have more ductility than traversing probe installations; the casing for traversing-probe installations is relatively large in diameter and somewhat more stiff/brittle in nature.

Traditional systems using large casing and smaller measuring elements (either traversing probe system or many styles of in-place inclinometers) can measure relatively large cumulative deformations; if shear planes are present, measured deformations over small lengths are generally limited to about 0.5 feet before the casing breaks or the curvature becomes so large that the traversing probe can no longer be pulled through the casing.

In-situ inclinometers generally consist of strings of inclinometer probes hooked together in a series or daisy-chain arrangement. These are typically comparatively expensive and often used across a finite area of interest to limit the number of sensors used. The sensor strings are placed in the conduit, similar to the technique used for the traversing probe, but then left in-place and hooked to a data recorder. As the sensors don't move, there is less of a source of error in aligning the sensors on subsequent surveys. A more practical benefit is that the sensors may be read more frequently by automated systems allowing for a better collection of data to be acquired for analysis of slope velocities and any triggering events.

A relatively recent product that has come to market is the ShapeAccelArray (SAA) which is a linear sensor system with MEMS accelerometer elements that is manufactured to project specific lengths. The system can be outfitted with measurement nodes at intervals of either 1 ft. or 0.5 m. The sensor array, similar to a typical garden hose in size, can be placed in protective conduit and installed similar to the casing of the traditional inclinometer systems. Advantages include a comparatively ductile design, a single data cable, and a relatively small form factor. The use of MEMS accelerometers results in a lower cost and simpler installation as compared to many "in-situ inclinometer" styles. Data from these systems is typically collected daily and can be locally stored or uploaded in near real time to data storage and web-based data presentation systems. MnDOT experience shows that these systems can measure larger deformations than traditional inclinometer casing allows and that the technology provides very good accuracy, precision, and reliability. Although the initial expense of these devices is higher than traversing probe systems, depending on the installation location and frequency of readings, the benefit of frequent readings, near-real-time data

presentation, and trigger and alarm features makes them a preferred technique in most circumstances for measuring horizontal deflections.

The accuracy, precision, repeatability, and reliability of the SAA systems using MEMS accelerometers for measuring settlement is significantly better than any of the fluid based settlement systems and similar to high-quality survey-grade total station and satellite-based differentially-corrected systems.

Use of either precision survey systems or SAA systems is recommended and preferred for monitoring settlement where possible as these systems are generally accurate to a precision of less than 2mm and have considerably better repeatability and reduced data scatter as compared to other more traditional systems. Use of these high precision systems is required for all monitoring of spread footing foundations where instrumentation is specified.

9.1.9 2D and 3D Position Surveys: Survey Reflectors, Targets, and Prisms

Where horizontal movement is of interest in addition to vertical movement, there are other techniques available to monitor position locations in X, Y, and Z dimensions.

Survey targets, reflectors, and optical prisms are relatively inexpensive and easy to install on structures or attach to posts which may be embedded in embankments and slopes. These targets may be periodically monitored by survey crews or by automated robotic total station systems. Automated systems are particularly useful where high precision or frequent readings are required. As with settlement plates, establishing fixed references is important to ensure accurate, repeatable, readings. Several optical backsights must be installed to ensure that there is a reliable system in place to provide a reference for the targets of interest for measurement. It is highly recommended that more backsights than are strictly necessary for operation be installed to provide a level of redundancy as on construction sites some instrumentation is usually compromised by grading and other activities.

There are also new methods which use satellite based GPS systems to determine changes and position and elevation. These systems are typically somewhat expensive, although they can be rented and deployed for specific important applications where traditional or automated surveying may be impractical due to construction activities or locations where fixed reference points are distant (such as on large construction projects, over water, or over soft or uneven ground where backsight and reference control points are not likely to be stable or may change with water/ice, or other seasonal effects. These systems may also be appropriate in confined areas where there may be obstructed sightlines along the ground, such as in railyards).

9.1.10 Piezometers (Standpipe, Drive Point, and Electronic)

Piezometers are instruments used to measure groundwater elevations, more specifically, piezometric head (as some instruments are capable of measuring soil suction). Different types of installations have different project constraints and benefits.

9.1.11 Standpipe Piezometers

Piezometers may be of several types, the most common is an open standpipe piezometer where a borehole is outfitted with one set (or a series) of impermeable inclusions and screen(s). The intent is to allow water, from a stratum (or multiple strata) of interest, into the borehole such that it can be directly measured by the elevation of water in the borehole, usually with a measuring tape or water sensor). Automated systems where a porewater pressure transducer is placed in the bottom of the standpipe and outfitted with a datalogger may also be used, if more frequent readings are of interest.

Generally, open standpipe piezometers measure the water head in a single stratum for ease of installation. This stratum may be near the ground surface to help assess any construction difficulties high water may cause; alternately, the boring may extend to a deeper, sometimes confined, stratum, where the water head is of interest. These types of installations work well for reasonably permeable strata. In silts and clay materials where the permeability is low and the flow is very slow, open standpipe installations are not very responsive and may not present an accurate picture of piezometric head, particularly if the changes in groundwater conditions are rapid. For these types of materials, CPT pore water pressure dissipation tests or electronic piezometers, or drive-point piezometers with electronic monitoring are better suited to measuring groundwater pressures with faster response times. Considerably less flow is required to create a response on the transducers. Electronic sensors, such as vibrating-wire-type pore water pressure transducers may be installed easily by direct-push techniques or installed in boreholes after they are established. If electronic piezometers are placed in traditional borings, care must be exercised to ensure they stay saturated during installation and that they are grouted in-place with an appropriate grout mixture (not cement) by experienced crews.

9.1.12 Drive Point (Standpipe and Vibrating Wire)

When piezometers are installed by CPT or similar systems without a rotating drill rig, they are referred to as “drive-point” piezometers. These installations often consist of a pipe and a screen which follow a disposable tip into the ground. This allows for a relatively fast and simple installation. In this case, the drive-point system functions much like a traditional open standpipe piezometer and is similar except for the installation practice.

When a direct-push system is used to install a sensor and the sensor is integrated into a probe, pushed into the ground and left in place, the overall technique is also referred to

as a drive-point-piezometer. When pushing sensors into the ground, care must be taken to prevent over-ranging the sensors.

9.1.13 Differences between Piezometers and Monitoring Wells

Due to various regulations, systems for measuring groundwater elevation where groundwater samples are not removed should be described as “Piezometers.” “Monitoring Wells” are installations where water is removed by sampling for testing external to the borehole and these installations have certain requirements associated with them, per MnDOT regulations. Piezometers and Monitoring Wells have different inventory (numbering, identification, status, sealing, and reporting) requirements.

The term “Monitoring Well” is to be avoided when referring to “piezometer” installations, as it does not apply, even if the in-situ infrastructure is similar, to minimize confusion among regulatory agencies. The basic difference, from a practical standpoint, is the removal of fluid (or lack thereof) from the borehole.

Note that if these installations are considered environmental boreholes they must be installed and sealed by a licensed well driller.

9.1.14 Vertical Slope Indicators (Manual)

Historically, slope indicators consisted of a metal cased traversing probe, a data cable, and an up-hole data readout or recording device. The basic operation consisted of lowering the probe into a borehole which had been previously drilled and outfitted with slotted casing (a slot at each 90 degree location around the circumference). The probe would be paused at intervals (usually 2 feet) as it was pulled up through the casing. Marks on the cable helped locate the intervals. When the probe reached the top the final set of readings for that run would be taken, the probe would be removed, rotated 180 degrees and lowered back down the hole for a second set of readings. By reversing the probe, there would be improved accuracy by compensating for any systematic drift errors.

This technique had many benefits- principally that the borehole casing was relatively inexpensive and the probe and related system could be used among many boreholes. As with the horizontal inclinometer casing, data on the inclination of the casing (and in this case the borehole) is obtained frequently along the length, creating a linear profile.

A drawback to the system is that it requires some skill to operate in the field to produce repeatable and reliable results. The operator should reuse the same probe for each data collection site, and trips to the site are required each time a dataset is required.

9.1.15 Vertical Slope Indicators (Automated- In-Place Inclinometers and SAA)

Similar to their use in horizontal applications, in-place inclinometers consist of linked probe segments in a slotted casing similar to the traversing probe systems. Benefits include the ability to measure the tilt at multiple points simultaneously and use

automated data logging to compile data more frequently than is generally possible with manually read traversing probe installations. These systems were basically adapted from traversing probe systems and there are some practical limitations on the number of sensors due to cost and cabling considerations.

Benefits of in-situ and SAA systems are that they remain in-place and data can be recorded much more frequently than with manual installations (on account of labor, time, and travel considerations). Reading the sensors more frequently is highly beneficial to help correlate events with other conditions, events, or triggers, such as high rainfall, low river water elevations, snow loading, ice formation, seasonal effects, thermal heating and expansion, etc... Remote data collection and near real time reporting via web-based systems has revolutionized geotechnical instrumentation and monitoring.

In vertical applications, the use of ShapeAccelArray (SAA) systems is similar to horizontal applications. Advantages are similar in vertical installations. The sensors have bi-axial accelerometers so that the tilt can be measured in two orthogonal directions, similar to the vertical traversing probe and in-place accelerometers.

MnDOT experience has shown that SAA sensors can operate in environments with comparatively large local and global deformations; this may be in part to the smaller more flexible protective conduit. Measurements of more than 3 feet within a few segments have been recorded before the sensor became non-responsive. Aggregate movements of over 10 feet were recorded on a single sensor over a 120 foot length prior to the system failing.

As with horizontal installations, the accuracy, precision, repeatability, and reliability of the SAA systems has been appropriate and beneficial for investigating a number of landslides and related lateral movements. Significant benefits have been realized from the ability to poll the sensors comparatively frequently and record high-quality rate data on slope velocities.

Use of SAA systems to monitor landslides and other features where vertical deformations need to be evaluated is recommended over traditional traversing probe inclinometer systems. These automated systems are required for high-profile projects, projects that are part of research studies, and all projects where any analysis and reporting requirements require readings to be taken weekly or more frequently during the construction or warranty periods.

9.1.16 Tiltmeters

Tiltmeters are useful for measuring angular rotation of retaining walls or other structural features (such as temporary sheeting or shoring elements). These systems are somewhat more susceptible to temperature variation than other sensors and as such, should be protected from changes in sunlight exposure and temperature as much as possible. In addition, they must be securely mounted to ensure that they are accurately responding to the tilt of the element being measured. If possible, it may be useful to install reference gages or redundant gages to assist in assessing the data. Tiltmeters are generally uniaxial (measuring tilt in one axis) although biaxial systems are available.

9.1.17 Strain Gages (Resistance, Vibrating Wire, and Fiber Optic)

Strain Gages are commonly used to measure both strain and stress. Strain is measured directly by the sensor and is a more reliable measure than the computed stress.

Strain measurements help compute total deformations; one such use of strain gages is to estimate the elastic shortening of a pile during a static load test or under bridge loading.

Strain gages are however more often used to monitor stresses. Stress is determined by using the stiffness of the element the strain gage is attached to. Where gages are mounted on steel elements with known areas, the relationship is fairly accurate. Where gages may be attached to concrete, rock, or composite sections of mixed materials, the stiffness at or near the gage location is less well defined and there is some inherent inaccuracy in the calculation for stress.

There are additional circumstances that can cause inaccuracies in stress calculations such as uncertainty as to the actual area of concrete in a composite steel/concrete section (there could be voids). Concrete stiffness also changes with time and confining pressure making calculations of load in concrete more uncertain than those for steel which has generally more uniform behavior.

There are several types of strain gages and mounting techniques for them. There are three general categories: electrical resistance (ER) gages, vibrating-wire gages, and fiber optic gages. Electrical resistance gages are relatively inexpensive and are best suited to projects where the monitoring is of a short duration as they have a tendency to drift over long periods. They can be read (polled for data) very quickly or continuously and are therefore very good for dynamic measurements. As they have no moving parts, they are reasonably rugged. Often small, they may be applied directly to surfaces; this does take some care. Water proofing and protecting the gages is important and also takes some care. Some gages now come in protective housings that can be bolted to elements. These gages are more expensive, but very sturdy and far less subject to installation difficulty and damage. They can be installed very quickly.

Vibrating wire (VW) gages are fairly robust and can survive pile driving installation. These gages are fairly stable with time and less subject to drift than ER gages.

Traditional vibrating wire gages take about a second to excite and read with a specialty VW logger (which electronically ‘plucks’ the wire in the system causing it to vibrate). The frequency of the vibrations is related to the length of the wire and the parameter being measured (i.e pressure). A series of VW sensors may take longer to read by an automated system as each gage is read in sequence by the logger. Some new systems use a continuously vibrating sensor and readout which allows faster dynamic measurements to be recorded. At this time the rate appears to be limited by the logger system to rates which are still slower than ER gages. There is some influence of temperature on these devices and each sensor is usually outfitted with a thermistor so that the sensor temperature is known to apply appropriate corrections.

Fiber optic gages are generally very stable in operation, have the ability to be mounted at large distances and long cable-runs from the data acquisition system, and are less susceptible to temperature variation and other external influences (such as lightning strikes). The sensors themselves are not powered so there is no need for electrical cables going to the sensors. They do require a small fiber-optic wire, which is somewhat delicate and requires a comparatively large amount of care during installation. While fiber optic cables can be spliced, this requires time and skill and the splice kits are expensive. Extreme care in placing fiber optic sensors is warranted to reduce the potential need for splicing or replacing sensors. As the sensor strings are usually custom fabricated, replacing sensor systems in the field would likely result in unacceptable construction delays.

A benefit of the fiber optic cable is that it is less bulky and can service multiple sensors in series. The fiber optic cables must not be tightly wound or kinked. Gages are usually prepared with factory manufactured lengths of fiber optic connector cable. Gages are mounted by spot welding, bolting or other methods. A diffraction grating system is mounted at the gage and depending on the strain, the sensor element will move. This change in distance is measured by an optical data interrogator which then calculates the deformation. The data interrogator is a relatively expensive device and the gages and wires are comparatively difficult to install properly. Fiber optic systems, at this time, are installed only in special circumstances.

Refer to the later section on ‘load cells’ for information on measuring load directly for improved calculations of stress.

9.1.18 Specialty Strain Gages: Optical Strain Sensor Geosynthetic

An interesting application of fiber optic strain gages is to install the gages as part of the manufacturing process of geotextile fabrics. TenCate/Mirifi makes a product called “geodetect” which has fiber optic sensors embedded within the reinforcing fabric. It can be ordered in specific lengths and used within embankments to monitor the reinforcement strain. The fabric can be used as the reinforcing fabric itself (which is the intent) or the fabric can be added simply to include the gages within a structure that is either unreinforced or reinforced with different materials.

This product has been used on a MnDOT demonstration project and shows some promise. As noted for fiber optic gages, the fiber optic wires are delicate and extreme care must be taken during installation to ensure that the fiber optic wire are not tangled, crimped, bent, or cut.

9.1.19 (Earth/Total) Pressure Cells

Earth Pressure Cells typically have a 'pancake' type fluid filled sensor area which is connected by a tube to a pressure transducer. The system is mounted in the field such that pressure (horizontal or vertical) is applied to the pancake-face. The pressure is then transferred to the liquid, which in-turn, acts on the pressure transducer.

These systems are calibrated by the manufacturer, but are very susceptible to stress concentrations and installation configurations when placed in situ. Depending on surrounding materials, these sensors can either tend to attract load or cause load to shed around them. In general, they are regarded as one of the more poorly performing geotechnical sensor types when an accurate magnitude of pressure is of interest.

Sensor accuracy and performance can be improved by calibrating the cells in confining chambers with similar soils and installation practice and applying known loads as part of a site-specific calibration routine. This is expensive and usually performed at research stations for research projects.

The sensors do perform well for relative comparisons where it is of interest to note where stress concentrations may be larger or smaller than other regions. The sensors are useful when used in combination with other information such as the fill height of embankments or known weight of retaining wall or bridge elements.

For a given project it is recommended that the same sensor type or style/manufacturer is used to limit the amount of variability. Different sensors can have different stress patterns at the face and comparing data among several different sensor types at different locations can introduce undesired complexity and increases the likelihood of evaluation errors. When placing the sensors, compaction and material around the sensors should be as homogenous as possible to improve performance

9.1.20 Load Cells

Load Cells are useful for determining load directly (without using strain gages and computing stress through stiffness relationships). Load cells must be inserted in series with elements being measured (similar to devices measuring current in electrical systems).

A load cell is a calibrated element which has collections of strain gages and known physical parameters. These elements are frequently inserted into the jacking system for temporary use during static load tests to better resolve applied loads with greater precision than the pressure gages on the hydraulic jack.

Because load cells are more expensive than strain gages and would require specialty mounting fixtures, they are less common for permanent (and sacrificial) load measuring systems, although they are very common for short term load and stress monitoring.

Osterberg Cells, used mostly in drilled shaft testing applications, are a type of load cell used in permanent geotechnical settings.

On laboratory devices, load cells are now common and have replaced older “proving rings” which had historically been used with dial gages and calibration charts to measure load and force.

9.1.21 Deflection/Deformation Sensors

Deflection or deformation may be used to measure gap closure or opening or other movements of interest in rock or other structures. Various technologies exist including LVDTs, string potentiometers, and manual devices such as dial gages, calipers, and micrometers.

9.1.22 Crackmeters

Crackmeters may be used to measure crack opening or closure of rigid materials; concrete, metal, rock, or other elements may be instrumented to determine if cracks open or close based on traffic, temperature, or other seasonal effects.

Simple, manually read, systems consist of two pieces of acrylic plastic, one with a reference grid, and a second overlapping transparent piece with cross-hairs. As movement occurs, the cross-hairs move with respect to the background reference grid. The amount of movement and the measurement date are recorded manually.

These systems may also consist of a LVDT or string potentiometer mounted across a crack. These electronic systems are outfitted with electronic data collection devices which can record data locally for periodic download or upload data on a regular basis to a collection site.

These systems are most often used to determine if there is unusual or undesirable movement within rock formations or between elements on walls or bridges (such as MSE Wall fascia panels).

9.1.23 TDR, LiDAR, InSAR and other useful, but specialized, techniques

In special circumstances, several additional technologies are also available to monitor linear and planar features. Time Domain Reflectometry (TDR) allows deformation to be monitored along linear elements. Special cabling and measuring devices are used to sense cross-section reductions in cables (where these anomalies are caused by the cable stretching in a local area). The difference in material geometry can be measured

by the measuring device and the location along the cable where the distress is present may be determined.

Light Detection and Ranging (LiDAR) and other systems allow movements of large areas to be compared against movements of known stable areas; similarly Interferometric Synthetic Aperture Radar (a satellite based system) allows ground movement to be assessed to a high precision from orbiting satellites which make regular passes over the Earth. These systems use bare earth or special reflectors as references. They are particularly useful to measure large or distant elements such as rockfall faces, bridge decks, roadways, airfield paving, and other types of features that reflect light and radar waves.

9.1.24 Research

While not generally a part of program delivery projects, MnDOT does partner with local universities and government agencies; there are occasions where structural and geotechnical instrumentation and monitoring is included as part of a project as an integral element of a coordinated research program. One example of this type of project is the instrumentation and monitoring of the performance of MnDOT's first GRS-IBS bridge abutment in Rock County, just east of Luverne, MN.

9.2 GIMP/GEMINI

While MnDOT frequently designs monitoring programs for embankments and structures, some projects require contractor-designed and implemented programs to aid in observing the performance of specialty structures, complex constructed works, or structures founded on geotechnically variable sites. This approach is used on design-build projects (St. Croix River Crossing, I-494/US169 interchange) as well as design-bid-build projects (Dresbach River Crossing).

9.2.1 GIMP

Recent projects, where there are geotechnical challenges, or where there is an interest in performance monitoring, have required the development and use of a Geotechnical Instrumentation and Monitoring Program (GIMP) such that geotechnical performance can be measured and observations documented to show that the work meets the required tolerances set forth in contract documents. The sensors described in the previous section are used to measure field properties as part of overall monitoring of geotechnical performance.

Sample types of geotechnical features a GIMP covers:

- Embankment settlement
(may also include monitoring 'lack of settlement' by use of lightweight fills)
- Soil pre-loads and soil surcharges for settlement reduction
- Spread footing foundation settlement monitoring
- Performance of retaining walls

- Ground improvement techniques and performance verification (i.e. column supported embankments)
- Slope stability
- Performance of new ponds and other specialty structures
- Performance (load/deformation) of driven piles, drilled shafts, and other foundations
- Sample types of content a GIMP document contains:
 - Location of exploration borings/soundings/tests
 - Number of features being monitored
 - Locations of features (plan)
 - Type of instrumentation
 - Location of instruments, including connection cabling, data collection cabinets, etc..
 - Cross sections and other diagrams
 - Frequency of sample readings
 - Frequency of reporting
 - How information is acquired/stored/reported/processed/accessed
 - Plan for how to replace lost/damaged sensors

Geotechnical monitoring, as a contractor responsibility, is a relatively new MnDOT practice; overall the implementation is going well and has provided beneficial information for determining that performance tolerances are being achieved.

9.2.2 GEMINI

In 2013, this concept is being expanded on some projects to include a more complete geotechnical framework which runs from exploration to long-term performance monitoring. The newly expanded “asset management” model is called GEMINI (Geotechnical Exploration, Monitoring, Instrumentation, Notification, and Informatics). In this expanded framework, the GEMINI plan more completely encompasses the totality of the components which are important to a successful understanding of geotechnical performance. Characteristics of each element include:

- Exploration and Site Characterization
 - Borings, CPT, DMT, PMT, VST, Exploration, Geophysics
 - In-Situ Testing, Lab Testing
- Monitoring (parameters being observed)
 - Stress, Strain, Tilt, PWP, Deformation, Velocity, etc...
 - Sampling Intervals, Monitoring Plan
 - Data Acquisition, Processing
- Instrumentation (sensors to measure properties being assessed)
 - Sensor Types, Locations, D/A, Cables, Support Hardware
 - Layout (plan and profile views)

- Notification
 - Alarms, Thresholds for automated warnings
 - Evaluation and Interpretation of data; incorporating context
 - Reporting; data formats, charts, graphs,
 - Data archival, summary reports

- Informatics
 - Right Information at Right Time to Right Entity in Right Way
 - Documentation, Data Assessment, Data Storage/Warehousing
 - Accessibility of project information

The change from a GIMP document to a GEMINI program represents the desire to more completely organize and present the geotechnical character of the original site and show the site, or structure, response to construction activities. The intent is for a more thoughtful and complete approach to performance monitoring in assessing the quality of design and construction solutions.

Outcomes may include:

- Improved design selections or refinements for future projects
- Innovations based on measured performance; potential cost savings
- Real time adjustment of construction practice if problems are seen
- Accelerated construction if used for construction control
- Shorter waiting periods
- Automated notifications can reduce risk and increase confidence
- Added documentation for showing acceptable/unacceptable performance
- Verification of new designs or value engineering solutions

Not every project will require a large investment in a GEMINI program approach. Small scale projects are equally adaptable to the intent of the program. It is anticipated that the new framework will help demonstrate there are aspects to performance monitoring which extend beyond sensor installation and data acquisition alone. The overall goal is to develop, for each project, a meaningful evaluation of the geotechnical and structural performance of transportation assets, where appropriate.

The large majority of MnDOT projects do not require performance monitoring, however there are those- such as where large embankments are constructed, or unstable slopes are to be remediated, where a GEMINI program approach is well worth the investment.

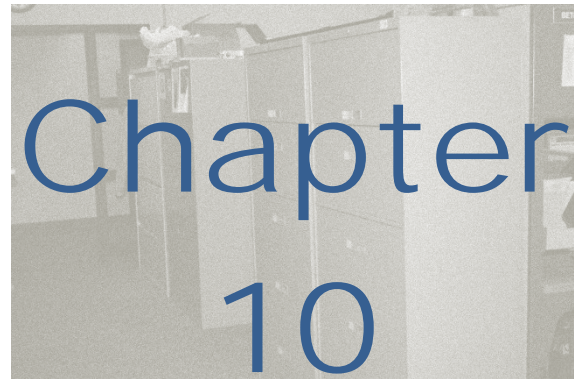

10 Information Management

Although geotechnical information has historically been acquired for use with respect to a particular project, the information obtained can also be quite valuable as a component of larger regional studies, such as groundwater or bedrock mapping, or as useful information for subsequent projects at the same site or nearby. Frequently, structures are rehabilitated in-place, or expanded for extra traffic capacity. In some cases, historic information may be adequate for the rehabilitation of existing structures or for the design and construction of new structures. Often, previous investigation data provides useful supplemental information or provides additional insight into site stratigraphy or variability. In some cases, historic borings may allow an expedited investigation, such as where additional site information is acquired by relatively fast geophysical exploration methods or use of CPT equipment.

It is now recognized that geotechnical data has relevance beyond the particular project for which the information is acquired. Accordingly, additional effort is made to record the locations of the investigations with enough precision and accuracy such that these records are meaningful for future work.

10.1 General Policy

MnDOT believes strongly that making geotechnical information accessible for both broader interpretation of the data and effective use for future projects provides better overall value for the original investments made in site characterization.

Today, many bridges are being reconstructed and the historic geotechnical records are of low quality or lost. For this reason, a significant emphasis is now placed on both retaining information associated with geotechnical investigations and making it accessible in digital formats that can be used both internally and externally.

10.2 Electronic Boring and Sounding Logs for State Projects and CSAH Projects

Borings and soundings taken by the Foundations Unit for MnDOT projects are assigned both project point ID names (refer to Chapter 2.4.6) and given a unique identification number, the MnDOT “Unique Number.”

When consultant drillers and CPT operators transmit boring log information to MnDOT, a Unique Number is given to each of those advances and the electronic data, provided by the consultant, is imported into MnDOT’s electronic boring log database.

Where borings are taken for County State-Aid Projects (CSAH) projects, electronic (PDF) copies of the field logs or the electronic logs (if in gINT or another similar electronic logging system) are to be transmitted to the Geotechnical Section so these logs can be entered into the state system and assigned Unique Numbers. Location information and other point-level metadata (such as elevation, date, driller, drill rig designation, etc...) must be included.

Supplemental borings for design-build projects are also to be transmitted for inclusion in the electronic database.

County, city, and other government entities funding or administrating work for projects that cross state and federal highways are also to transmit the boring log information to MnDOT to include in the electronic data archive.

10.3 Filed and Archived Information

Some archived information is retained at the MnDOT Office of Materials and some has been archived off-site. Original boring logs, usually in the form of the field log and an attached ‘finalized’ lab log, are filed separately from project information. In addition to the Unique Number files, project files are also archived. There is usually a hard-copy file in addition to electronic data records.

Legacy data was generally archived with a copy of the project report attached to the first boring log; this process became somewhat less formalized with the migration to electronic data storage in the past 15 years and recent project reports (available readily electronically) have not been attached to the field logs in recent years.

An archival project was conducted in the early 2000’s where a large number of legacy boring logs were scanned into PDF file format; this process was not complete for all borings and there are some which remain only in paper format. These borings are being slowly scanned as resources permit. As projects arise where legacy data is relevant, these borings are entered into the electronic database system and borings are electronically generated. As part of current practice, information from borings and soundings is entered into a project database and logs are electronically generated into PDF format.

10.4 Rock Cores

After rock cores are classified, they are entered into gINT following the process described in Chapter 5. Rock cores are placed in on-site storage for the remainder of the project. Once the project is complete cores are entered into a database and each core box is assigned a number. (To best maximize storage, a core box may include rock from different core runs or even different projects). Core from this database is periodically sent to the DNR rock core storage in Hibbing, MN. The database includes coordinates, project numbers, structure types and other information, such as depth intervals, on each core. The Geology Unit maintains information on cores sent. Contact the Geology Unit for more information.

10.5 Design Information

Geotechnical design information is presented in the “Foundation Investigation and Recommendations Report” or similar report for each structure or project, depending on the complexity of the project. These reports are typically transmitted to design engineers, District soils and materials engineers, and the pre-design and construction sections of the Bridge Office.

Reports are saved in the geotechnical section on local servers for archival purposes and placed in either EDMS or ProjectWise files for access by others.

Plans, Special Provisions, and other project documentation is maintained by District design and construction personnel. In general, copies of final documents are not maintained within the Geotechnical Section, except for special projects (typically those that include research aspects, static load testing, or other performance monitoring).

10.5.1 Diagrams/Drawings

Occasionally, diagrams and drawings are prepared for reports. Copies of these are usually archived on local servers, although they are not labeled systematically. At present, the best way to locate original copies of special diagrams and drawings is to contact the project report author.

10.6 gINT Logs

Since about 1994, MnDOT has been imputing boring log data into electronic project-based databases. Information on project-level, point-level, and depth-level data is recorded and archived. Final project boring logs are generated in Adobe PDF format and included in project reports.

Various design templates allow both SPT borings and CPT soundings to be exported in a variety of formats. Specialty logs can also be created to assist with reporting functions for the Minnesota Department of Health.

In addition, the logging software also allows simplified logs to be exported in an electronic file suitable for importing into CAD programs such as AutoCAD and

Microstation. Some scaling may be required when importing these electronic files depending on system settings and units of measure.

10.7 Field Logs (SPT and CPT), Lab Logs, Lab Data

Historically, for SPT borings MnDOT drillers have used paper logs in the field to record drilling operations and sample information. These “field logs” have information recorded in pencil on 8.5x11 sheets (usually assembled into 11x17 field packets). These logs are sent in to the Foundations Lab with soil samples and after additional testing, test results are added to the field logs. Classifications may be added or revised based on lab evaluation of samples, moisture content tests, or additional lab testing. Typically, rock identification and classification is first detailed by lab review by geologists. After this additional information is added to the paper log the log information is then entered into the project gINT database. A final “lab log” is then generated which has the original information, augmented by any lab updates or changes. Usually the field information is edited and abridged; not all the drilling operation notes and field notes are transferred to the final log. An engineer will review the logs, and if the drilling information appears relevant, it will then be added to the logs in the description or remarks areas.

The electronic nature of CPT data storage has resulted in a somewhat different data practices for these logs. Typically, a field journal is kept by CPT operators to record location data and to serve as a daily diary of work performed. Practices have changed periodically; some early soundings were taken with summary information being recorded on a field log and this process persists for borings with sampling or other testing to help accurately record sensor information. In general, the CPT software records data in a proprietary format which is later converted into gINT records by use of 3rd party software (RapidCPT by DataForensics, Atlanta, GA). This conversion is typically conducted by the SPT operator and the file provided to the field crew support staff. GPS information is added and the data is validated as the project information is finalized and checked.

In 2000, a number of lab systems were replaced and improved. With the addition of automated electronic testing and associated data recording, most test data is archived electronically and only summary lab results are transferred to the lab logs. More complete information is available in the project files or in the electronic data archive.

The final disposition of the original SPT field logs is to have the electronic copy of the lab log printed as a hard-copy and then attached to the field log; both logs are then filed in the Unique Number files.

CPT soundings are sometimes printed as a hard copy and included in the Unique Number files, although this process is less rigorously conducted (due to the absence of a field log for these tests). CPT soundings where there is a field log (usually for piezometer installations or soil samples) are generally printed as hard copies to include in the Unique Number files. DMT advances are filed similarly to SPT and CPT sampling logs although they do not pass through the Foundations Lab as part of the process.

10.8 Web Based Data: Geotechnical ArcIMS, “Gi5”, GIS Application

MnDOT Foundations borings and CPT soundings that have both depth information and reasonably accurate location data have been imported into an aggregated database which is searchable in an on-line web based format. Log information can be accessed through a map interface using the MnDOT base map. Additionally, information is searchable by a number of different parameters including the point ID, MnDOT Unique Number, or by State Project, Highway, County, or several other search parameters.

The on-line web-based application can be most easily reached by typing “Gi5” and “MnDOT” into a web search engine.

The system allows the user to create an HTML or a MS Excel output of summary data from the boring logs. This data includes the location information and certain meta-data attributes.

Some legacy data is not in the Gi5 application due to data loss or data quality problems. There are a number of legacy borings that do not have sufficient information to locate them with any accuracy or precision; the location references are vague, absent, or based on external references that cannot be found or recreated. In addition, some logs themselves have been misfiled or possibly inadvertently destroyed. It is estimated that these problems extend to less than 2% of the historic logs.

10.9 “GeoAPP” Smart Device Availability

The web-based database and GIS application currently does not contain recent borings (after 2007), although the system is currently being updated to incorporate newer logs.

A related application which performs the same service and is designed for tablets and smart devices is expected to be available to supplement the web-based system in mid-2014. This system is in development at this time and is also being developed to include additional geo-asset information on MnDOT transportation works of geotechnical interest.

10.10 Location Data Quality

Legacy borings, where location information was generally recorded by station and offset (prior to 1995), may have comparatively poor coordinate information in the electronic databases. Historic information was “bulk” processed where the legal description of the boring location (used for MnDOT reporting) was used to assign modern coordinate information. As such, a boring may have been located in an area roughly 330 foot square and assigned an arbitrary coordinate in the NE corner of the portion of the section-township-range are in which the boring was advanced. The likely maximum error is therefore about 467 feet, although most locations will be more accurate. If groups of borings appear to be clustered at ‘grid-like’ locations, it is likely a result of this approximate location process. Some legacy data has been updated if there was a

nearby project where more accurate information was desirable. In general, location information is updated as legacy information is needed for current projects.

More information on data quality is presented online as part of the Gi5 system documentation; click on the lower right button on the landing/splash page.

10.11 Aggregate Source Information System

The Office of Materials developed the Aggregate Source Information System (ASIS) in 1985. It is a database used to store and retrieve information relating to aggregate sources (gravel pits and rock quarries). A 5-digit number is assigned to each aggregate source prior to testing for tracking purposes. MnDOT Labs will not test aggregate material unless it has a 5-digit source number. If the aggregate site does not have a number, one can be obtained using this [form](#). ASIS does not contain all quality and quantity information for an aggregate source. ASIS pit or quarry condition data may not always be up-to-date, so current status of an aggregate site should be verified.

10.11.1 Description

The [ASIS Interactive Map](#) is a geographical representation of the gravel pit and rock quarry data that is in ASIS. The Geology Unit manages this database.

10.12 Health Department Records

MnDOT operates its geotechnical exploration within the guidelines and regulations established and enforced by the Minnesota Department of Health. Drill rigs and CPT vehicles are licensed and operated by drillers and technicians who work for licensed practitioners.

Borings are advanced and sealed according to MnDOT regulations if they are environmental boreholes (EBH). Refer to earlier sections for a description of environmental boreholes. Records of drilling operations, soils, and locations for environmental boreholes are submitted to MnDOT.

10.13 Project Close-Out and Archive/Upload

As projects are completed, boring log data is validated (boring log designations and descriptions are reviewed and checked) and coordinate information checked for accuracy. A copy of the completed report along with any hard-copy project information is placed in a file folder, labeled with the state project number, highway, and a brief project description. Any original logs are removed from the project file and placed in the Unique Number file, after the printed electronic logs (PDF files) are attached. Electronic copies of the PDF files are placed in the electronic archive such that they can be accessed by the web applications. The boring logs are named by their Unique Number.

10.14 Project Based Boring Log Information

Periodically, projects are large and it is impractical to include all the relevant borings and CPT soundings in the project plans. In these cases a link to the project borings is provided in the project plans or special provisions and the boring logs are made available through the MnDOT Foundations Unit website for use and download.

In these cases, these borings are part of the project documents and they should be reviewed with the rest of the project information.

References

American Association of State Highway and Transportation Standards

American Association of State Highway and Transportation Officials (AASHTO) Designation, R 8-96, 2004, Standard Recommended Practice for Evaluation of Transportation Related Earthborne Vibrations

American Association of State Highway and Transportation Officials (AASHTO), 1988 "Manual of Subsurface Investigation"

American Society for Testing and Materials, ASTM

Bieniawski, Z.T., 1989, "Engineering Rock Mass Classifications", John Wiley & Sons

Briaud, Jean-Louis and Tucker, Larry M, 1996, Design and Construction Guidelines for Downdrag on Uncoated and Bitumen Coated Piles, NCHRP

Deere, Don U., 1989, "Rock Quality Designation(RQD) after 20 Years, U.S. Army Corps of Engineers, Waterways Experiment Station, Contract Report No. GL-89-1

Design Manual, Washington State Department of Transportation, 2013, M 22-01.10
<http://www.wsdot.wa.gov/Publications/Manuals/M22-01.htm>

Dowding, Charles H., 1996, Construction Vibrations, Prentice-Hall, Inc, Upper Saddle River, NJ

Driscoll, Fletcher G., 1986, Groundwater and Wells, 2nd Edition; St. Paul, MN, Johnson Division

Federal Highway Administration, August 1980, FHWA-TS-80-224, "Highway Subdrainage Design"

Federal Highway Administration, May 2002, FHWA NHI-01-031 "Subsurface Investigation"

Federal Highway Administration, September 2003, FHWA-IF-04-021 "Application of Geophysical Methods to Highway Related Problems"

Federal Highway Administration 1989, FHWA-IP-89-008 "The Pressuremeter Test for Highway Applications"

- Federal Highway Administration, February 1992, "The Flat Dilatometer Test" Figure 4.1 DMT Equipment Preparation, page 17
- Federal Highway Administration 1989, FHWA-IP-89-008 "The Pressuremeter Test for Highway Applications"
- Federal Highway Administration, February 1992, "The Flat Dilatometer Test" Figure 4.1 DMT Equipment Preparation, page 17
- Fetter, C.W., 2001, Applied Hydrogeology, 4th Edition; Upper Saddle River, New Jersey, Prentice Hall
- Geotechnical & Pavement Manual Part 1, 1994, State of Minnesota Department of Transportation
- Hendriks, Rudy, 2002, Transportation Related Earthborne Vibrations (Caltrans Experiences), Technical Advisory, Vibration TAV-02-01-R9601, Sacramento California, California Department of Transportation
- Jones & Stokes, 2004, Transportation- and construction-induced vibration guidance manual, June (J&S 02039) Sacramento, CA. Prepared for California Department of Transportation, Noise, Vibration, and Hazardous Waste Management Office, Sacramento, CA.
- Minnesota Department of Transportation, 2007, LRFD Bridge Design Manual, Section 2.4.1.6.2 Buried Utilities
- Powers, J. Patrick, 1992, Construction Dewatering New Methods and Applications, 2nd Edition, John Wiley & Sons
- Road Design Manual, Minnesota Department of Transportation, 2012, <http://roaddesign.dot.state.mn.us/roaddesign.aspx>
- Siskind, D.E, Stagg, M.S., Kopp, J.W., Dowding C. H., 1980, Structure Response and Damage Produced by Ground Vibration from Surface Mine Blasting, RI8507 OSM, U.S. Bureau of Mines.
- Woods, Richard D., 1997, NCHRP Synthesis 253, Dynamic Effects of Pile Installations on Adjacent Structures, National Academy Press, Washington, D.C.